



# Patient Handling and Movement Assessments: A White Paper

*Prepared by the*  
**2010 Health Guidelines  
Revision Committee  
Specialty Subcommittee  
on Patient Movement**

*Martin H. Cohen, FAIA, FACHA, Chair  
Gaius G. Nelson, RA, Vice Chair  
David A. Green  
Roger Leib, AIA, ACHA  
Mary W. Matz, MSPH, CPE  
Phillip A. Thomas, AIA  
et al.*

*Carla M. Borden, editor*

This document is intended for free public download and sharing.

© 2010 The Facility Guidelines Institute  
1919 McKinney Avenue  
Dallas, TX 75201  
info@fgiguideines.org  
www.fgiguideines.org

### **Primary Authors**

Martin H. Cohen, FAIA, FACHA  
Healthcare Architecture and Design for Aging  
Vice Chairman, 2010 Health Guidelines Revision Committee

David A. Green  
Center for Community Partnerships, University of Wisconsin Oshkosh

Gaius G. Nelson, RA  
Nelson-Tremain Partnership Architecture and Design for Aging

Roger Leib, AIA, ACHA  
Principal, Leib & Leib, Inc. Architecture & Product Design/Development

Mary W. Matz, MSPH, CPE  
Safety and Occupational Health Manager, Office of Public Health and Environmental Hazards  
Veterans Health Administration, Department of Veterans Affairs

Phillip A. Thomas, AIA  
Golden Ventures

Design by: GLM Design, Falls Church, VA.

Cover photograph: Deer River Health Care Center, Deer River, Minn.  
Courtesy of DSGW Architects, Duluth.

***Readers should note that the material in this white paper is advisory and is not intended to be used as regulatory or accreditation requirements.***

# CONTENTS

Preface .....	4
Introduction .....	6
Acknowledgments .....	9
Illustration Credits .....	11
Glossary .....	12
<b>Chapter 1: Rationale for Including the PHAMA in the 2010 Guidelines for Design and Construction of Health Care Facilities .....</b>	<b>15</b>
Hazards of Manual Patient Handling .....	18
Impact on Risk of Caregiver Injury	
Impact on Quality of Patient Care	
Current Patient Handling and Movement Equipment Categories .....	22
Benefits of Patient Handling and Movement Technology .....	23
Improving the Workplace and Reducing Risk of Injury	
Improving the Quality of Care	
Design Considerations and the Provision of Safe Patient Care Environments .....	24
Flooring Materials and Finishes	
Space Constraints	
Storage Space	
Door Openings	
Hallway Widths	
Floor/Walkway Slopes and Thresholds	
Elevator Dimensions	
Headwalls/Service Utility Columns	
Weight Capacities of Toilets and Mounted Objects	
<b>Chapter 2: Explanation of PHAMA Components .....</b>	<b>29</b>
PHAMA Text in the 2010 Guidelines .....	30
The Impact of Bariatric and Morbidly Obese Patient Care on Design .....	39
<b>Chapter 3, Part 1: Establishing the Business Case for a Patient Handling and Movement Program .....</b>	<b>42</b>
Savings in Patient Health and Quality of Life .....	42
Caregiver Savings .....	43
Financing .....	43
Grants and Similar Funding Sources	
Accrued Savings Based on Use of PHAM Equipment	
Out-of-Pocket Capital Investment	

<b>Chapter 3, Part 2: Establishing the Business Case—</b>	
<b>Understanding and Increasing the Value of a PHAMP at Your Institution</b>	<b>45</b>
The Simple Answer and the Fly in the Ointment	45
Decision Analysis Methodology	46
The Decision Analysis Approach	47
Decision Elements	
Framework for a Good Decision	
Understanding the Value	49
Basis Development and Deterministic Structuring	
Probabilistic Analysis and Review	
Internal Rate of Return	
Increasing the Value	55
A Compelling Case	56
<b>Chapter 4: Facilitating Acceptance of a PHAMP and PHAM Technology</b>	<b>58</b>
Getting Started	60
Promote the Safe Patient Handling Concept to Leadership	
Identify a SPHM Facility Champion/Coordinator	
Institute a Facility SPHM Advisory Team	
Promote Critical Connections	
Implementing and Maintaining a PHAMP	61
Develop Strategic Plans	
Select and Implement PHAMP Elements	
Develop Standard Operating Procedures (SOPs)	
Facilitate Change and Program Acceptance	
Evaluate the PHAMP	67
<b>Chapter 5: A Vision of the Future of PHAMPs</b>	<b>69</b>
Perspectives for Achieving Optimal Patient Handling and Movement	69
Patient-Centered Focus	
Caregiver Focus	
Systems Thinking	
Rethinking Basic Elements	
Ideas for Improvement	70
Short-Term Solutions	
Future Developments in Technology	
<b>Chapter 6: Patient Handling and Movement Resources</b>	<b>72</b>
General	72
Design Guidance	72
Clinical Guidance	73
VA Toolkits/Resources	74
Web Links	74
Selected Journal Articles	74

## Appendices

### Chapter 1

Appendix A: High-Risk Manual Patient Handling Tasks by Clinical Area .....	77
Appendix B: Legislative Report .....	79
Appendix C: PHAM Equipment Categories .....	85
Appendix D: Sling Selection Chart .....	93

### Chapter 2

Appendix E: Patient Care Ergonomic Evaluation Process .....	96
Appendix F: Patient Care Ergonomic Evaluation: Staff Interview Template .....	98
Appendix G: Equipment Evaluation and Selection Process .....	99
Appendix H: Clinical Unit/Area Characteristics and Ergonomic Issues Survey .....	106
Appendix I: Ceiling Lift Coverage Recommendations by Clinical Unit/Area .....	112
Appendix J: Floor-Based Lifts Coverage Determination .....	115
Appendix K: Design/Layout Considerations for Ceiling/Overhead Lift Tracks .....	118
Appendix L: Storage Requirements for PHAM Equipment .....	124
Appendix M: Infection Control Risk Assessment— Matrix of Precautions for Construction and Renovation .....	127
Appendix N: Bariatric Equipment Safety Checklist .....	132

### Chapter 4

Appendix O: Making Critical In-House Connections for PHAMP Success .....	133
Appendix P: PHAMP Element Descriptions .....	136
Appendix Q: Safe Patient Handling and Movement Training Curricula Suggestions .....	141
Appendix R: PHAMP Marketing Activities/Strategies Aimed at Staff .....	143
Appendix S: Safe Patient Handling Peer Leader Unit Activity and Program Status Log .....	145
Appendix T: Patient Care Equipment Use Survey .....	147

*Readers should note that the white paper materials are advisory and are not intended to be used as regulatory or accreditation requirements.*

# PREFACE

The 2010 HGRC Specialty Subcommittee on Patient Movement began studying the issues related to use of patient handling and movement (PHAM) equipment in health care facilities in early 2007. In the course of sharing our research and expertise with one another, we learned there is an abysmal lack of knowledge and information on this subject throughout the architecture and design professions and only a slowly growing recognition in regulatory agencies and in the health care industry itself—a fact we are convinced must be addressed.

During the time we worked on this document, the health care industry, nurses' associations, health care labor unions, federal and state regulators, and many state legislatures have been arguing for and against the capital costs associated with bills that would mandate minimal lift policies and the use of assistive devices to prevent caregiver injuries. To date, nine states have adopted safe patient handling legislation or resolutions, but most of the proposed bills and enacted legislation have provided only unfunded mandates for policies, studies, and demonstration projects. Only Minnesota and Washington have actually committed funds for grant or loan programs to assist with the acquisition of lift equipment.

Concern about making capital expenditures in the face of shrinking Medicare and Medicaid reimbursement rates has prompted many health care executives to hope that Congress will fund a legislative mandate. Representative John Conyers of Michigan did introduce such federal legislation in 2006 and again in 2007, but in both cases the bills died in committees of the House of Representatives without being scheduled for a vote. Conyers recently reintroduced his bill in the current Congress and Senator Al Franken of Minnesota has introduced a companion bill in the Senate; grassroots lobbying efforts are under way.

In reviewing this history, the specialty subcommittee observed that to justify the expenditures required to develop studies and implement the acquisition, installation, and training programs needed to equip and operate health care facilities

with safe lifting technology, most legislative and regulatory efforts have focused exclusively on workplace safety and the costs directly related to injured workers—as well as indirect costs such as those for continually replacing and training skilled nurses and other health care workers. This emphasis on workplace safety as the primary motivator has meant that, to date, programs (whether proposed or implemented) have been almost universally identified as safe patient handling (SPH) programs. Consequently, both current federal legislative proposals seek new occupational safety regulations, to be developed and administered by the Occupational Safety and Health Administration (OSHA).

However, our reviews of the literature, discussions, and debates have sensitized us to many additional advantages that PHAM equipment may offer, including:

- Better patient outcomes and improved quality of life for both patients and caregivers
- Economic benefits from avoiding adverse events related to manual patient handling
- The potential for hospitals and nursing homes to mobilize patients using assistive devices immediately following a procedure or admission and diagnosis

We have concluded that all of these benefits and possibilities deserve to receive more emphasis—in addition to (rather than instead of) workplace safety.

Accordingly, we have chosen the more generic and descriptive label of “patient handling and movement” (PHAM) to identify this subject, with the goal of widening the discussion and highlighting our recommendation that the health care industry must recognize, focus on, and develop the far greater potential we perceive for the equipment and technology employed in these systems. Thus, instead of SPH, in the 2010 Guidelines and in this white paper, we generally have employed terms that are variations on PHAM, such as PHAMA (patient handling and movement assessment) and PHAMP (patient handling and movement program).

After two and a half years of intense deliberation and debate, we are convinced the PHAM aspect of the health care industry is still in its infancy. As legislatures and authorities having jurisdiction broaden their horizons, look beyond the concept of safe lifting, and focus on all the issues involved in safe patient handling and movement in hospitals, ambulatory care, residential care facilities, and other venues, we hope they will begin to give more weight to the potential advantages and savings to be realized from the shorter lengths of stay, fewer readmissions, and reductions in caregiver injuries and adverse patient events anticipated from regularly using PHAM equipment.

And when they do, we trust that both the 2010 Guidelines requirement to conduct a PHAMA for every health care construction or renovation project and this white paper may serve as catalysts: both to encourage innovative health care projects based on further equipment research and development, and to guide project decision-makers toward the realization of safe patient handling and movement throughout the nation's health care facilities.

*Martin H. Cohen, FAIA, FACHA  
Chairman, 2010 HGRC Specialty Subcommittee on Patient Movement  
Vice Chairman, 2010 Health Guidelines Revision Committee*

# INTRODUCTION

MARTIN H. COHEN, FAIA, FACHA

The 2010 edition of the Facility Guidelines Institute *Guidelines for Design and Construction of Health Care Facilities* (the 2010 Guidelines or FGI Guidelines) introduces a requirement for project applicants to conduct a patient handling and movement assessment (PHAMA) as part of the sequence of predesign functional and space programming processes for new construction and renovation projects. Further, the 2010 Guidelines requires applicants to revise that PHAMA as new information becomes available throughout project design, construction, and commissioning.

PHAMA findings, recommendations, and revisions are intended to inform development of the functional program for a project, then its space program, and ultimately its design, construction, and commissioning, by keeping the design and construction team advised about the patient handling and movement (PHAM) equipment and associated accessories to be used and accommodated in specified locations. Such advice includes information about any spatial, structural, utility, or design considerations related to the installation, storage, maneuvering, servicing, and use of such equipment and thus should be updated whenever changes occur in that information.

The Steering Committee of the 2010 Health Guidelines Revision Committee (HGRC) commissioned its Specialty Subcommittee on Patient Movement to develop this white paper with a number of goals in mind:

1. To provide users of the Guidelines with background information on the new PHAMA requirement and the rationale for including it in the 2010 edition. (See Chapter 1.)

The white paper aims to help readers appreciate both the hazards of manual patient handling and the potential benefits of using PHAM equipment. To make the latter point, the current state of the art in PHAM equipment is described.

2. To provide readers with information and resources to help them prepare a PHAMA for a project. (See Chapter 2 and its many appendices.)

What to consider and how to evaluate the needs of patient populations when preparing a PHAMA for a project are discussed as well as the components of a PHAMA. Although based on the experience of the Department of Veterans Affairs (VA), which clearly has set the pace in implementing safe patient handling (SPH) programs in the United States to date, the material presented here can be adapted to the unique patient population, caregiving staff, project conditions, and available resources of any health care facility.

3. To help readers establish a business case for implementation of a patient handling and movement program (PHAMP). (See the two parts of Chapter 3.)

In analyzing costs and benefits, we believe the potential advantages and savings that assistive devices and new technology may offer—including advantages to caregivers, benefits for patients, and operational savings to be realized by health care organizations—must be quantified and considered. This white paper offers, for the reader's consideration, a description of the potential savings and financing options, plus a decision analysis program that Stanford University Medical Center, in Palo Alto, Calif., successfully employed to convince its decision-makers to implement a PHAMP. We think this methodology offers a prudent risk analysis strategy that should encourage project decision-makers, the agencies that approve and finance their projects, and the industries that compete for and service those projects to engage in further product research, design, and development and to invest in innovative project solutions based on that research.

4. To help health care facilities implement the recommendations for acquisition of PHAM



equipment and implementation of technology programs defined in their PHAMAs for every new construction and renovation project. (See Chapter 4 and its appendices.)

We discuss how to facilitate a patient handling and movement program (PHAMP) and encourage technology acceptance. We share how the VA has successfully addressed staff behavior change to improve the quality of patient care. A PHAMA, with its focus on instituting ergonomics in facility planning and design, is only the beginning of a successful PHAMP. Another critical part is implementation of organizational PHAMPs that incorporate change management strategies to help caregivers and patients adapt to the organization's PHAM equipment. When new PHAM technology is introduced, caregivers must essentially change the way they work, and patients must also become acquainted and comfortable with new equipment and care regimens.

5. To challenge equipment designers, manufacturers, facility planners, architects, and project executives with "Visions of the Future of Patient Handling and Movement Programs (PHAMPs)." (See Chapter 5.)

Recognizing that the most appropriate and effective equipment and accessories to meet every patient's physical and medical needs may not yet be universally available, we advocate going back to basics and responding to cherished beliefs and great expectations about where this industry could and should be going.

Recent articles in medical and nursing journals have stressed that increased mobility and mobilization are no longer simply options for patients and residents—they are a medical necessity. In the design of care environments as diverse as critical care units in hospitals and bathing spas in nursing homes, many experts believe that early mobilization and safe patient handling and movement must be considered as basic as provisions for infection prevention and power outages. Per those authorities, the old model of sedentary care is unsafe and a thing of the past; mobilizing patients must be accomplished in a way that is safe for both caregivers and the patients who depend on them.

While researchers all over the world continue to study whether there is a direct causal link between patient outcomes and the use of mechanical assists, many medical and industry experts have discerned that relationship on an anecdotal basis, and the industry is responding. Physical therapists, occupational therapists, orthopedic and rehabilitation nurses, and their professional associations are all pushing for the use of lifts for movement (including self-ambulation and assisted and independent mobilization), not just lifting. Companies are promoting lifts to serve these functions as well. Better slings are being developed, and many stakeholders appreciate the relationship between mobilization and improved patient outcomes.

Given the increasingly hazardous biomechanical demands on caregivers today, it is clear the health care industry must rely on technology to make patient handling and movement safe. To encourage these trends, equipment and accessory designers and manufacturers must make their systems affordable enough to be purchased and installed, and user-friendly enough for caregivers and patients to embrace their use. And, working in concert with facility planners and designers, they must also make them attractive enough to be selected for use in patient-centered, homelike environments, and locate them conveniently enough for timely use, throughout the spectrum of caregiving facilities.

6. To provide resources for additional information regarding patient handling and movement. (See Chapter 6 and endnotes throughout the white paper.)

Endnotes (which appear at the end of Chapters 1–5 and some appendices) provide sources of information on specific subjects likely to become relevant during preparation of a PHAMA. A further list of resources is provided in Chapter 6 to assist readers who may want more information before making decisions or reaching conclusions about subjects addressed in their PHAMA.

To the best of our knowledge, no previous reference work has addressed the issues of design

and construction related to patient handling and movement in health care facilities as we have done here. The authors of the FGI Guidelines (the members of the HGRC) trust that this white paper will begin to fill a critical gap in the education of Guidelines users, by helping them better understand the many complex issues related to patient handling and movement for the patients and caregivers involved. We also hope the white paper may prove helpful to the facility managers, administrators, and regulators who oversee construction and renovation projects as well as the decision-making executives, trustees, and corporate directors who fund them. The guidance offered and the resources identified are intended to help each facility determine the needs of its unique patient population and caregiving staff and define the most appropriate strategy for meeting those needs in the context of its unique community, facility project requirements, and available resources.

As used in this white paper, the term “movement” includes—in addition to lifting—both assisted transfers (e.g., from bed to wheelchair, stretcher, toilet, etc.) and transport to a destination (e.g., from patient room to diagnostic imaging, physical therapy, etc.) as well as mobilization (i.e., both assisted and independent exercise and/or ambulation using assistive devices and/or mobility aids). Also note that, although people who enter hospitals and certain kinds of ambulatory care facilities for care are usually referred to as “patients” or “clients,” and those who live in long-term care venues may traditionally be known as “residents,” the term “patient” is used throughout this document to represent all three types of users, in new and existing health care facilities. All PHAMA considerations apply equally to all recipients of care.

Readers should note that the white paper material is advisory and is not intended to serve as regulatory or accreditation requirements.

# ACKNOWLEDGMENTS

The consensus process through which the FGI Guidelines are developed typically makes it almost impossible to identify an individual author as responsible for a specific section of the Guidelines. While a proposal may be submitted by a member of the Health Guidelines Revision Committee (HGRC) or the general public, the review process through which texts are crafted, challenged, debated, revised, and wordsmithed by task groups, subcommittees, and/or the full HGRC typically makes each part of the consensus document truly a group product.

For this white paper, however, each chapter was researched and drafted by a specific individual or group of individuals as principal authors; often supplemented by sidebars or sections prepared by contributing authors. Thus, although every chapter was vigorously debated and revisions were suggested by members of the 2010 HGRC Specialty Subcommittee on Patient Movement as well as our editors, the final version of each chapter is the responsibility of and has been credited to the principal and contributing authors identified in each chapter.

Outstanding among this group was Mary Willa Matz, MSPH, CPE, without whom, it may truly be said, this white paper probably would not exist. This certainly was a labor of love for Mary. Like all HGRC members, the specialty subcommittee members were volunteers, working on the white paper on their own time during evenings, lunch hours, weekends, and vacations. But Mary gave up many hours of personal time for nearly two years! She originally was invited to participate as an outside stakeholder because of the expertise she has developed in her work in the VA National Patient Care Ergonomics Program. However, Mary became so involved in the work of the HGRC and had so much to contribute, she was invited to join the HGRC and participated in all three of its all-hands meetings. Not only did she author three of the white paper chapters, and contribute significantly to two others, she also participated in almost every conference call and critiqued almost every part of this document from cover to cover.

We should note that while Mary's material is the result of work supported with resources from the Veterans Health Administration and the use of facilities at the James A. Haley Veterans' Hospital in Tampa, the findings and conclusions relayed by Mary W. Matz in this document are those of Mary W. Matz and do not necessarily represent the views of the Department of Veterans Affairs.

We are particularly grateful to John Celona, BS, JD, a Palo Alto, California-based management and economics consultant who, though neither an HGRC or specialty subcommittee member, volunteered to write Chapter 3 about the Business Case when he met Mary and learned about this white paper.

We also are indebted to David A. Green and Roger Leib, who co-authored Chapter 5, plus sidebars for other chapters; and to Gaius G. Nelson, RA, and Phillip A. Thomas, AIA, who authored parts of Chapters 2 and 3. Like Mary Matz, all of these gentlemen also generously contributed insights drawn from their vast and diverse experience as well as their energetic and entrepreneurial spirits and good humor, devoting untold hours to researching, reviewing, critiquing, debating, and improving virtually every part of this white paper.

Other authors who contributed either parts of chapters or sidebars that have enhanced the scope and quality of this white paper include:

Judene Bartley, MS, MPH, CIC

Martin H. Cohen, FAIA, FACHA

James W. Harrell, FAIA, FACHA

Jane Rohde, AIA, FIIDA, ACHA, AAHID, LEED AP

Wade Rudolph, CBET, CHFM

David M. Sine, MBE, CSP, ARM, CPHRM

David Soens, PE, RA

The Specialty Subcommittee on Patient Movement was a subcommittee of the 2010 HGRC. While HGRC focus groups are composed exclusively of HGRC members, specialty subcommittees comprise both HGRC members and invited outside stakeholders. When formed at the initial meeting of the 2010 HGRC in April 2007, the Patient Movement group had an initial

membership of 21 HGRC members and 11 outside stakeholders. Many of those original members sat in on work sessions at the second and third all-hands meetings of the HGRC in 2008 and 2009. However, as the work progressed through a grueling series of bi-weekly (and sometimes weekly) conference calls to review the contents of successive research efforts, outlines, and drafts over a period of 30 months, the following core group of committed individuals emerged as clearly deserving of recognition for their dedicated service and generous contributions in support of this white paper. Their varied backgrounds, vast experience, innovative thinking, cooperative spirit, and steady advice have truly made this document what it is:

Martin H. Cohen, FAIA, FACHA, Chair  
 Gaius G. Nelson, RA, Vice Chair  
 Carla M. Borden, Editor  
 David A. Green  
 Roger Leib, AIA, ACHA  
 Mary W. Matz, MSPH, CPE  
 Phillip A. Thomas, AIA

Other much appreciated contributors, who helped shape the final product either by participating in conference calls or by preparing drafts or reviewing drafts by others, included:

Ramona Conner, RN, MSN, CNOR  
 Thomas W. Jaeger, PE  
 Lorraine G. Hiatt, PhD  
 Thomas M. Jung, RA  
 James W. Harrell, FAIA, FACHA  
 Rita Rael Meek, RA  
 Wade Rudolph, CBET, CHFM  
 David Soens, PE, RA

Special recognition also is in order for the superior work of two superb professionals, our editor Carla M. Borden and our executive editor Pamela James Blumgart. If this white paper seems intelligible and makes sense to you, it undoubtedly is thanks to their tireless efforts.

Finally, we should like to express our thanks to the Steering Committee of the 2010 HGRC for their encouragement, support, and guidance throughout the development of this paper. And to the FGI Board of Directors for their financial support of this white paper and offering to host it on the FGI Web site: [www.fgiguideelines.org](http://www.fgiguideelines.org). We are delighted that FGI will make it available free of charge to the public and invite the public to comment and submit suggestions for its improvement. We hope and trust this white paper will help you realize safe patient handling and movement programs in your facility projects.

*Martin H. Cohen, FAIA, FACHA  
 Chairman, 2010 HGRC Specialty Subcommittee on Patient Movement  
 Vice Chairman, 2010 Health Guidelines Revision Committee*

# PHOTOGRAPHY CREDITS

The photographs included in this white paper were provided courtesy of the organizations identified here; they are reprinted with permission and copyrighted to the manufacturers, all rights reserved.

**ArjoHuntleigh Inc.** focuses on patient mobility and wound management solutions.  
[www.ArjoHuntleigh.com](http://www.ArjoHuntleigh.com)

**Dane Industries**, manufacturer of medical devices for safe patient handling.  
[www.danetechnologies.com](http://www.danetechnologies.com)

**DSGW Architects**, a multi-office architecture firm with expertise in health care planning and design.  
[www.dsgw.com](http://www.dsgw.com)

**Ergolet**, manufacturer of overhead and portable lifts for safe patient handling.  
[www.ergolet.com](http://www.ergolet.com)

**Guldmann Inc.**, manufacturer of patient lifts for safe patient handling.  
[www.guldmann.net](http://www.guldmann.net)

**HoverTech International**, manufacturer of the Hovermatt and Hoverjack for safe patient handling.  
[www.hovermatt.com](http://www.hovermatt.com)

**Integrity Medical Products**, manufacturer of integrated patient lifting systems.  
[www.integritymp.com](http://www.integritymp.com)

**Liko™**, a Hill-Rom Services Inc. company, manufacturer of patient lifting systems.  
[www.hill-rom.com](http://www.hill-rom.com)

**RoMedic Inc.**, manufacturer of transfer, positioning, support, and lifting products for safe patient handling.  
[www.romedic.com](http://www.romedic.com)

**Stryker Medical**, manufacturer of patient care and handling equipment.  
[www.stryker.com/medical](http://www.stryker.com/medical)

**TransMotion Medical Inc.**, manufacturer of mobile, motorized treatment and transport stretcher-chairs for safe patient handling.  
[www.transmotionmedical.com](http://www.transmotionmedical.com)

**Wright Products Inc.**, manufacturer of the Slipp® for safe patient handling.  
[www.wrightproductsinc.com](http://www.wrightproductsinc.com)

# GLOSSARY

**Air-assisted lateral transfer device:** A patient transfer mattress that utilizes the force of air to decrease friction and ease movement of patients (in a supine position) from one surface to another. Also decreases shear forces on the skin of patients during lateral transfers. (See Appendix C.)

**Ambulate:** To walk or move about from place to place with or without assistance.

**Bariatric patients:** Persons overweight by more than 100 lbs. or with a body weight greater than 300 lbs., or (more commonly) with a body mass index (BMI) greater than 40.

**Biomechanics:** The study of the application of the laws of physics and engineering to define and describe movement of the body and forces that act upon the musculoskeletal system.

**Body mass index (BMI):** a patient's weight (in kilograms) divided by the square of a patient's height (in meters).

**Caregiver:** Any person who provides direct patient care, including moving and handling patients. Caregivers are of varying clinical disciplines and educational levels and may work in any area where patient handling and movement occur, including long-term care; acute care; home-based care; dental or radiology/diagnostics practices; therapies; and the morgue.

**Ceiling or overhead sling lift:** Lifting equipment used for dependent patients and patients requiring extensive assistance. The motor that lifts the patient is attached to a track or rail suspended from the ceiling or attached to the wall. The motor functions to raise or lower the patient and sometimes to move the patient horizontally. (See Appendix C.)

**Client:** A recipient of care; a consumer of care services.

**Culture of safety:** The collective belief of those within a work environment that safety is a shared responsibility and is integral to staff and patient safety.

**Cumulative trauma disorder:** The outcome of repeated damage, or an accumulation of damage over time, to a specific area of the musculoskeletal system. This damage includes micro-injuries such as micro-tears to the muscles and micro-fractures to the vertebral endplates of the spine. When uncontrolled, such micro-injuries result in more significant injuries, which often appear to be acute.

**Ergonomics:** The scientific study of the relationship between work being performed, the physical environment where the work is performed, and the tools used to help perform the work. The goal of ergonomics is to provide a workplace designed to ensure that the biomechanical, physiological, and psychosocial limits of people are not exceeded.

**Ergonomic shower chair:** A powered commode/chair that is height and longitudinally adjustable to place a patient in a position for ease in personal care. (See Appendix C.)

**Floor-based sling lift:** Lifting equipment with a wheeled base that rolls on the floor and can be moved from room to room or area to area. Used for dependent patients and patients requiring extensive assistance. The lift motor functions to raise or lower the patient but caregivers must manually push the lift and patient to the desired location. (See Appendix C.)

**Friction-reducing device:** Devices made of slippery materials that reduce friction during sliding movements, making it easier to move a patient from one place to another or to reposition a patient in a bed or chair. (See Appendix C.)

**Gantry lift:** Lifting equipment used for dependent patient and patients requiring extensive assistance. This type of lift is placed over the bed of a patient and functions similarly to an overhead/ceiling lift. (See Appendix C.)

**HGRC:** Health Guidelines Revision Committee.

**High-risk patient handling tasks:** Patient care activities that result in musculoskeletal injuries in caregivers. Tasks are considered high risk based on their frequency and duration and the degree of musculoskeletal stress imposed by the task.

**Infection control:** Decreasing the risk of or preventing the invasion and multiplication of microorganisms in body tissues. Also, decreasing the risk of releasing microbiological materials into the environment.

**ICRA:** Infection control risk assessment. (See Appendix M.)

**ICMRM:** Infection control risk mitigation recommendations. (See Appendix M.)

**IP:** Infection preventionist.

**Lateral transfer:** Horizontal movement of a patient in a supine position from one flat surface to another (e.g., from a bed to a stretcher or bathing trolley).

**Lifting equipment (lifts):** Mechanical devices used to assist caregivers in performing patient handling tasks, including lifting, transferring, wound care, ambulation, and others. Lifts fall into two categories: powered sit-to-stand lifts and full-body sling lifts. The latter category is further broken down into overhead/ceiling, gantry, and floor-based lifts. (See Appendix C.)

**Lift team:** Caregivers organized into teams of two or more whose responsibility is to move and handle patients throughout the hospital. Team members receive specialized training in safe lifting and moving techniques utilizing patient handling equipment.

**Manual patient handling:** Lifting, moving, sliding, transferring, or otherwise caring for a patient without mechanical assistance.

**Mechanical lateral transfer devices:** Powered by an electric motor or manual crank, these devices attach to a draw sheet or something similar and pull the patient from one surface to another. (See Appendix C.)

**Mobilize:** To move from place to place either with assistance or independently to help a patient maintain or increase physical activity and movement, involving the entire body or just limb/s.

**Musculoskeletal disorder (MSD)/musculoskeletal injury (MSI):** An injury to or disorder of the musculoskeletal system, including muscles, bones, joints, tendons, ligaments, nerves, cartilage, and spine. Most work-related MSDs develop over time. MSDs typically affect the back, neck, shoulders, and upper limbs; less often they affect the lower limbs.

**No-lift, zero-lift, or minimal-lift policy:** A policy that prohibits or minimizes manual lifting by instituting a patient handling and movement program (PHAMP).

**Patient:** A recipient of care; also used in this white paper to refer to clients and residents in residential care facilities.

**Patient care ergonomic (PCE) evaluation:** Use of ergonomic principles to evaluate the ergonomic hazards in a patient care environment in order to generate recommendations for control measures, including patient handling equipment and programmatic recommendations such as institution of a PHAMP and standard operating procedures for maintenance/repair and storage of patient handling equipment. (See Appendix E.)

**Patient handling and movement assessment (PHAMA):** Structured guidance to direct and assist the design team in incorporating and accommodating appropriate patient handling and movement equipment into the health care environment.

**Patient handling and movement program (PHAMP):** A program for reducing ergonomic risk for caregivers and patients from patient handling activities. Includes support structures and change management strategies to facilitate use of patient handling equipment and foster a culture of safety in the patient care environment.

**Patient handling equipment:** A variety of tools or devices used to assist caregivers in performing patient handling tasks (e.g., transferring, ambulating, repositioning, lifting, toileting, transporting, and many other tasks). (See Appendix C.)

**Patient handling tasks:** Tasks performed by caregivers when caring for patients, including bathing, transferring, wound care, repositioning, feeding, and many more. Those considered high risk result in injury when performed manually without assistive devices.

**Peer leaders:** Caregivers who represent their clinical unit or area as safe patient handling and movement champions and experts. They are informal leaders who have specialized training in safe patient handling and movement.

**Repositioning/positioning:** Adjusting a patient's position in bed or chair to prevent pressure ulcers, promote comfort, accommodate physiological functioning, or raise the patient to eye level to facilitate communication.

**Resident:** A recipient of care in a long-term/residential care facility.

**Sit-to-stand lift:** A lift that used to raise a patient from a seated position and lower him or her to another seated position. The patient must have some upper body strength, cognitive ability, weight-bearing capability, and the ability to grasp with at least one hand. (See Appendix C.)

**Sling:** A fabric device used with mechanical lifts to temporarily lift or suspend a patient or body part to perform a patient handling task or to reposition/position a patient in bed or chair. Sling styles include seated, standing, ambulation, repositioning, limb support/strap, supine, toileting, bathing, and others. (See Appendix D.)

**Supine:** Lying on the back or having the face upward.

**SPH:** Safe patient handling.

**SPHM:** Safe patient handling and movement.

**Transfer:** The movement of a patient from one place to another (e.g., from a wheelchair to a toilet—vertical transfer—or from a bed to a stretcher—lateral transfer).

**Transfer chairs:** A device that converts from a chair into a stretcher and back. In the stretcher position, the device facilitates lateral transfers. (See Appendix C.)

**Transport assistive device:** Usually battery-powered devices that caregivers use to help move patients from one location to another. These devices attach to handles of wheelchairs and to beds, and the caregiver simply guides the direction of the bed or wheelchair. (See Appendix C.)



# CHAPTER 1

## Rationale for Including the PHAMA in the 2010 Guidelines for Design and Construction of Health Care Facilities

*Principal author:*

MARY W. MATZ, MSPH, CPE

*Contributing author:*

ROGER LEIB, AIA, ACHA

A significant impediment to providing safe and therapeutic environments of care is the practice of manual patient handling. Manual patient handling—lifting, transferring, positioning, and sliding patients without assistive technology—has been the norm in health care facilities for decades. Nonetheless, it is an unsafe practice for both caregivers and patients.

Manual patient handling puts caregivers at considerable risk for musculoskeletal injury: Researchers have found that more than 80 percent<sup>1</sup> of nurses are injured at some point since, in the most basic terms, there is no safe way to

manually lift or move a patient without mechanical assistance. The increasing number of morbidly obese, bariatric, and sicker (and thus more dependent) patients who must be moved for various caregiving tasks adds to the amount of stress on caregivers' bodies. It requires little imagination to realize that caregiver injury has effects on staffing, organizational costs associated with lost time and workers' compensation, and—significantly—the quality of patient care.

Manual patient handling also increases the risk of injury, pain, and negative health outcomes to patients, in part because of the effects such

### Caregiver Tasks That Cause Concern Around Safe Patient Handling

Every day, caregivers transfer, position, mobilize, and support the ambulation of patients. Providing this assistance manually, in the traditional manner, can involve excessive physical effort, which is further complicated when tubes and other devices tether a patient to fixed outlets and utilities. To be done safely, handling and moving adult patients of any size must be performed with the aid of special equipment designed for that purpose.

Optimally, patients mobilize and ambulate themselves or, for the sake of patient dignity, at least assist in the process. Therefore, the equipment and protocols caregivers use must remove as much risk of physical injury from the physical environment and care process as possible.

The following descriptions of the types of assistance caregivers typically provide are intended to serve as a basis for understanding what constitutes patient handling and movement, the associated need for assistive devices, and how use of these devices affects the physical health care environment.

#### Transferring

There are two general categories of transfers: movement of a patient (1) from one flat surface to

another flat surface and (2) from perch to perch (from one seated position to another seated position or to/from a seated position from/to a supine position).

#### *From one flat surface to another (lateral transfer).*

Although increasing numbers of procedures are performed patient-side, dependent patients must still be transported throughout a care facility and often they must be moved from the surface on which they are lying to another flat surface in order to be transported. Such “lateral” or “slide” transfers are also commonly performed when moving dependent patients onto treatment, diagnostic, and procedure tables/surfaces. When performed manually in a location where no rails or armrests interfere, such lateral transfers generally include these movements: The caregiver brings the destination surface (bed, gurney, etc.) to the location of the transfer and aligns it longitudinally alongside the originating surface. When performed manually, in a conventional fashion, one, two, or more caregivers, standing on the open sides of both the origination and destination surfaces, grab the drawsheet

*sidebar continues on next page*

tasks have on caregivers. Further, manual patient handling, along with the often infrequent use of assistive technology, may restrict opportunities for patient movement, mobilization, and weight-bearing activities, which can compromise patients' recuperation, rehabilitation, and overall health. Again, the costs of ignoring risks caused by manual patient handling go beyond

the financial to the health, and ultimately the quality of life, of patients.

The primary solution to the problems of manual patient handling lies in assistive patient handling and movement (PHAM) technology. Some countries have national policies that ban manual lifting; in the United States, federal legislation is pending, and several states have adopted

*sidebar continued from previous page*

and either pull or push it—and thus the patient—to the destination surface.

**From perch to perch.** “Perch” refers to a bed, chair/sofa, toilet or toileting chair, dependency chair, or wheelchair—the key furnishings on which a patient comes to “perch” in the patient room.

Given conventional furnishings, there is frequent need for movement between perches (from a sitting position in one location to a sitting position in another location). In long-term care environments, care instructions and protocols typically demand that residents spend as much of the day out of bed as possible. In hospital settings, patients must often be “up in a chair” beginning as early and for as long as possible. Respecting patient dignity also implies minimal use of bedpans in favor of a toilet or bedside commode. As well, patients are transported throughout a care facility for a variety of diagnostic, treatment, and other procedures.

For “manual” transfers from a flat or reclined position, the caregiver usually assists the patient to a sitting position and rotates the patient’s body while lifting or assisting movement of the patient’s legs over the side of the bed. From such a seated position, the caregiver lifts the patient up from the perch, pivots the patient a “quarter-turn,” and then lowers the patient onto the new perch. When transferring from a seated position onto a bed or other flat surface, the caregiver may use a twisting motion to lay the patient down. More independent patients can use transfer aids/devices to move themselves to/from a bed and wheelchair when arms or rails do not impede such a move.

### Positioning/Repositioning

Patients are moved or repositioned for a number of reasons:

**To accomplish patient care tasks.** Patients may be moved to facilitate performance of a clinical procedure or patient care task, such as those listed below. In all these cases, the entire body, an upper or lower portion of the body, the head, or a single limb may need to be moved or brought into and maintained in a particular position.

- Examining a patient
- Performing a procedure, from minor surgery to re-bandaging, catheterizing, intubating, etc.
- Performing personal hygiene tasks
- Grooming and feeding
- Providing emergency or “code”-response care. Not infrequently, due to extenuating circumstances, these procedures are carried out with the patient on the floor.

**To prevent bedsores and other position-related adverse outcomes.** A patient’s position should be changed at least every two hours, even at night, to prevent bedsores and/or minimize pooling of upper-respiratory fluids and to optimize infusion of oxygen into the lungs. This activity involves rolling patients from one side onto the other, and placing pillows or other supportive materials next to the patient to temporarily hold that position. It is one of the most frequent manual moves performed by caregivers.

**To reposition patients for their comfort and safety.** Returning a patient who has slid down in bed to the head of the bed is also a frequent manual move performed by caregivers. A patient who slumps down in a chair, wheelchair, or dependency chair also needs to be pulled up. Caregivers attending a conference in 2008 anecdotally reported as much as 50 percent of their time with patients was spent repositioning them. These moves typically are among the highest-risk tasks performed by caregivers.

### To address a clinical condition.

- Patients are positioned/repositioned in bed to ease breathing and/or reduce nausea.
- The upper bodies of patients with compromised breathing function—commonly including bariatric patients—must be raised, usually to a standard minimum angle.
- Hypotensive patients are historically positioned with the head lower than the body.
- During feeding of debilitated patients, swallowing raises the risk of aspirating fluids or solids into the lungs and developing aspiration pneumonia, so it is important to maintain a vertical upper body position.

such legislation. Government, professional, and industry groups strongly support ergonomic interventions in the form of assistive technology to keep caregivers and patients safe. However, to facilitate acceptance and use of such new technology by caregivers, programmatic and organizational support structures must be put in place. Patient handling and movement programs

(PHAMPs) as described in Chapter 4 of this document promote the use of such technology and also facilitate organizational change by incorporating program elements that foster values essential to an effective culture of safety.

That PHAM technology is not more widely employed is partly a function of the constraints of the built environment. Space must be adequate

**To enhance communication.** Communicating with patients at eye level supports patient dignity and enhances the quality of communication.

### **Mobilization and Ambulation**

When the human body is immobile, it deteriorates after a short period of time. Early and frequent mobilization of a patient or resident is thus critical to maintaining or regaining health. Many providers observe that the earlier a patient is mobilized (particularly getting the patient up on his or her feet and walking), the better the outcome. Conversely, many immobility-related adverse events, some with long-lasting consequences, are linked to late or insufficient mobilization.

As it relates to safe patient handling and movement, mobilization includes the following:

- Moving the limbs of dependent, non-weight-bearing patients to preserve joint flexibility. This involves taking limbs through their full range of motion.
- Ambulating patients as early and as often as possible to maintain mobility and bone density. Recent evidence suggests the need for early or immediate and frequent ambulation applies even to some of the highest acuity patients, such as ventilator-bound patients in the ICU, who in the past were left immobile. Patient ambulation involves a caregiver(s) supporting a patient on one or both sides, with the risk of suddenly having to prevent a fall.

### **Lifting Off the Floor**

Manually lifting patients who have fallen is another task that is high-risk for both caregivers and patients. A concern particular to this activity is ensuring that the patient is stable and has not been injured; thus, examination and caregiving must be provided in an awkward position from the floor. As well, lifting a patient who cannot help from the floor is undoubtedly one of the most difficult patient handling tasks caregivers perform.

### **Transportation**

Transporting patients long distances and/or up and down inclines can be very difficult for caregivers and dangerous for patients. Transport devices used

to take a patient from one area of a facility to another (e.g., to radiology or a special treatment or procedure area) include stretchers, gurneys, beds, transport chairs, wheelchairs, and (less frequently) portable bathing trolleys.

The fact that patients may need to be transferred onto these transport devices from less mobile or less maneuverable perches (see Transferring above) creates risk for both patients and caregivers in these situations. Additional challenges and risks arise from having to push, pull, shove, and maneuver the devices to reach a destination, while at the same time overcoming difficulties presented by soft floor coverings, ramps, thresholds, inadequate clearances and turning radii, and so on.

Perhaps the greatest risks occur in emergency situations when there is no time to transfer a patient from a hospital bed onto a more specialized transport device and caregivers undertake to use the already-heavy beds as patient transport vehicles.

### **Wound Care**

In performing wound care, caregivers must lift patients' heavy limbs and hold them in place throughout what can be lengthy procedures. Additional difficulties result when a wound is located on a part of the body that is difficult to access.

### **Toileting**

Assisting a patient in toileting is potentially one of the most difficult caregiver tasks. The difficulty of trying to suspend a patient over a toilet while performing personal hygiene for them is rarely discussed. And patient falls, often serious, occur most frequently between bed and toilet.

Most institutions and caregivers subscribe to the value of maintaining patient dignity by helping patients as necessary to relieve themselves in/on a built-in toilet within a private enclosure. However, patient size, weight, dependency level, intubation, and hour of need often shortcut these aspirations with the following, less-desirable alternatives:

- Bedpans, a sometimes humiliating if necessary default of choice

*sidebar continues on next page*

for equipment use and storage; weight capacities sufficient for mounted objects; and flooring surfaces, slopes, and clearances conducive to smooth movement of rolling equipment. For such accommodations to be provided as necessary, architects and other designers must know the facts and possible solutions. The patient handling and movement assessment (PHAMA) is intended to facilitate the incorporation of assistive technology into the design of health care facilities to ensure safety and positive health outcomes for patients as well as safety and positive work environments for their caregivers.

*sidebar continued from previous page*

- In-cabinet toilets built into cabinetry and lacking a sense of privacy
- Portable bedside commodes
 

Enabling patients to safely reach the toilet is a major concern of caregivers. It is sufficiently difficult when patients signal their intentions, but even more so when patients do not. Confusion, compromised balance, poor lighting, unfamiliarity with environmental obstacles, and inadequate door clearance for caregiver-assisted visits to the toilet all exacerbate these concerns.

### Showering/Bathing

Safely getting a dependent patient into and out of a shower (or tub, where still used) represents significant difficulties and dangers for caregivers and for patients. Bathing commonly takes place in these venues:

- In bed
- In an in-room shower (within the patient bathroom), often on a wheeled shower chair
- In a shared bathing room with or without adequate clearances for maneuverability and necessary patient transfers
- On a portable bathing trolley wheeled from the patient room to the shower room
 

Showering/bathing a dependent patient presents a unique set of difficulties:

  - The patient is in a highly vulnerable emotional (and physical) state.
  - All areas of the patient's body must be reached, including the perineal area. To accomplish this, patients and limbs must be lifted and turned, and, depending on the position of the patient, caregivers must reach or stoop as necessary, sometimes for extended periods.
  - Working conditions can be wet and slippery, and floors are sloped for drainage.
  - Patients are at greatly increased risk of falls.

## Hazards of Manual Patient Handling

Always unsafe, manual patient handling has become even more so today. As patient acuity levels and weights have increased, so has recognition of the benefits of patient mobilization. With more demands for mobilization of increasingly dependent and larger patients come additional risk of injury for both caregivers and patients.

Today, higher patient acuity levels are commonly found in most clinical settings (e.g., patients formerly considered medical/surgical patients are often found today in nursing homes).

### Surgery

Transferring patients onto and off of a surgical table presents all the usual difficulties inherent in performing lateral transfers, along with others stemming from location in the surgical suite rather than the patient room.

### Vehicle Extraction

Patients arrive at health care facilities in varying states of consciousness, physical and emotional fragility, and pain; they are also of different sizes and weights. Some are able to leave their car independently, but many cannot exit and lift themselves to a standing position. Assisting these patients from a vehicle, often from the back seat, frequently requires contortions on the part of caregivers. The task is further complicated by the urgency of emergent situations.

### Patients Presenting Special Challenges

Care of obese/bariatric patients and combative patients takes patient handling and movement challenges to another level. Considering all the patient handling activities noted above, risk of injury to both caregiver and patient is compounded when obese/bariatric or combative patients are involved. Therefore, careful consideration must be given to all details of the special challenges such patients present. Those suffering with dementia often become combative if they feel frightened or frustrated by something or someone. This problem is not confined to special Alzheimer's care units, since many long-term nursing facility administrators report that up to 80 percent of their general patient populations may manifest at least some degree of dementia. [For further information on one specific aspect of this problem, see A. L. Barrick et al, ed. *Bathing Without a Battle: Personal Care of Individuals with Dementia* (New York: Springer Publishing Company, 2002).]

*Roger Leib, AIA, ACHA*

Despite this fact, most health care facilities are not equipped to handle the growing population of morbidly obese and bariatric patients. Another especially significant factor in the quality of care being provided is the global nursing shortage, which may be due in part to the overwhelming use of manual patient handling and movement techniques. The impact of manual patient handling can be seen in injuries to the aging caregiver workforce, the difficulty facilities have recruiting and retaining qualified nurses, and the number of injured nurses of all ages.

### Impact on Risk of Caregiver Injury

For more than 30 years, training in body mechanics and “proper” lifting techniques was the control measure of choice for decreasing injuries related to manual patient handling. Yet during this time, injuries from manual patient handling continued to increase.<sup>2</sup> The reason for this? Lifting

patients has been found to exceed caregivers’ biomechanical capabilities.<sup>3, 4, 5, 6, 7, 8</sup> It was recently determined that 35 lbs. is the maximum weight a caregiver should manually lift under the best of circumstances (e.g., no tubes, contractures, combative behavior, etc.).<sup>9</sup> No amount of training in proper body positioning or lifting will prevent injury when the load exceeds what the body can tolerate. We all may be aware of the potential for transmission of infection and disease from patients to caregivers, but many of us do not consider the ergonomic hazards caregivers face from manually lifting, moving, and handling patients.<sup>10</sup>

A comparison with other general industry occupations highlights the gravity of the situation. As can be seen in Figure 1-1, injury rates in the farming and construction industries have decreased significantly over time, while those in the nursing and personal care industry have not.

## Biomechanics of Patient Handling Injuries

Carrying out an activity that exceeds a person’s biomechanical capabilities causes damage to the musculoskeletal system. Manually lifting patients who weigh more than 35 lbs. (even under optimal circumstances) is such an activity and, consequently, caregivers are injured.<sup>11</sup> In acute injuries, damage occurs when one event results in an injury: For instance, six caregivers attempt to manually move a 500-lb. patient, and the excessive load results in a serious muscle tear to one or more caregivers. However, most patient handling injuries come from cumulative traumas. A cumulative trauma injury results from the accumulation of micro-injuries over time and often manifests itself in what would seem to be an acute injury. These cumulative traumas are not only the more common but the more insidious of musculoskeletal injuries. Such micro-injuries, in the form of micro-tears in the muscles or micro-fractures on the end plates of spinal vertebrae, often progress silently over time, until severe damage occurs.<sup>12</sup> While the focus here is on damage to the muscles and spine, joints and bones can also be compromised. Most patient handling injuries are located in the lower back, but injuries also occur in the middle and upper back, shoulders, neck, arms, wrists, and even the hands and knees.

When muscle exertion occurs over an extended period of time or too often without adequate recovery, the muscle becomes fatigued and is no longer able to produce energy for

contraction. Muscle fibers also can be damaged from excessive loading or repetitive actions without sufficient recovery periods.<sup>13</sup> With continued lifting and moving of excessive loads (patients), micro-tears eventually progress to a major tear,<sup>14</sup> and a person may be surprised when, in a simple motion of bending over to pick up a pencil, his or her “back goes out.”

Excessive spinal loading is a consequence of lifting heavy loads and even light loads for a long period of time. Such lifting results in compressive forces on the spine. Twisting, reaching, bending, pulling, and other similar motions produce shear forces on the spine that also add to spinal loading.<sup>15</sup> When a person’s spinal load capacity is surpassed, vertebral endplate micro-fractures occur and scar tissue is formed. Normally, nutrients easily diffuse through a healthy vertebral endplate into the adjacent disc, but endplate scar tissue impedes the flow of these vital nutrients. (Discs lack a blood supply and must gain their nutrients by means of diffusion through their adjacent vertebral endplates.) Without adequate nutrient flow, a disc degenerates until nerve impingement results in pain and decreased work capacity. The frightening aspect of this insidious injury cascade is that the discs have no nerve supply to warn of the degeneration, and so caregivers are most likely unaware that such a cumulative trauma injury is progressing until damage has been done.<sup>16</sup>

**Figure 1-1: Comparison of Injury Rates in Construction, Nursing and Personal Care, and Farming**

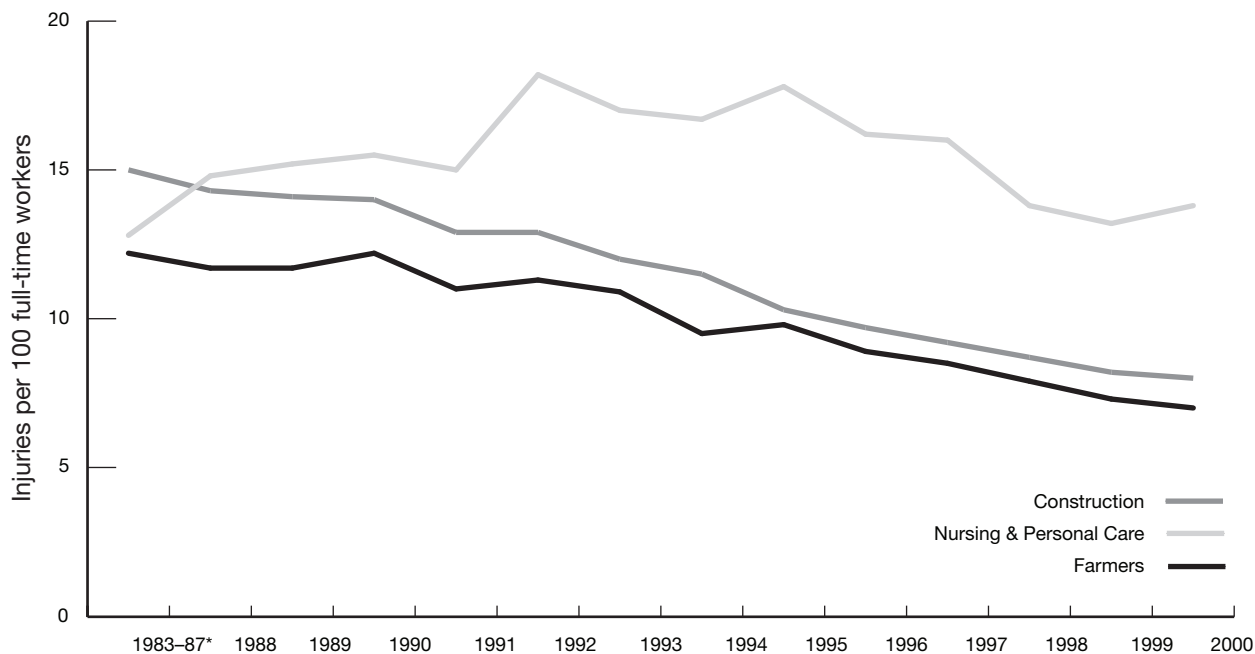

\*Baseline figure

Source: U.S. Department of Labor, *Annual Survey of Occupational Injuries and Illnesses* (2001)

**Table 1-1: Nonfatal Injuries and Illnesses Involving Musculoskeletal Disorders with Days Away from Work**

Nurses' aides/orderlies and attendants	29,980
Registered nurses	8,810
Licensed practical and vocational nurses	3,400
<b>Nursing TOTAL</b>	<b>42,190</b>
Laborers/freight-stock-materials movers	33,590
Truck drivers (heavy/tractor-trailer)	17,770
Truck drivers (light-delivery services)	12,450
Construction/laborers	9,190

Source: U.S. Department of Labor, Bureau of Labor Statistics, *Lost-Work Time Injuries and Illnesses: Characteristics and resulting time away from work—2003* (April 10, 2004).

**Table 1-2: Comparison of Work-Related Injuries and Illnesses in Three Health Care Industries (2007)**

Health Care Industry	Number of Work-Related Injuries and Illnesses
Hospitals	264,300
Ambulatory health care services	127,500
Nursing care facilities	121,100
<b>Total</b>	<b>512,900</b>

U.S. Department of Labor, *Survey of Occupational Injuries and Illnesses* (2007)

**Table 1-3: Reported/Accepted Non-Fatal MSDs\* Requiring Days Away from Work with Ranking Between All Occupations**

	Number of MSDs Requiring Days Away from Work	Comparison of Ranking
Nursing aides, orderlies, and attendants	24,340	2nd highest
Registered nurses	8,580	7th highest

\*Musculoskeletal disorders  
U.S. Department of Labor, *Survey of Occupational Injuries and Illnesses* (2007)

Other comparison data from 2003 (see Table 1-1) shows that nurses' aides/orderlies and attendants, registered nurses, and licensed practical and vocational nurses have a much higher incidence of musculoskeletal injuries (and associated lost time from work) than laborers/freight-stock-materials movers, truck drivers, and construction/laborers.

According to 2007 information, there were 512,900 work-related injuries and illnesses (see Table 1-2). The seriousness of this injury data is substantiated by injury data broken down by occupation. In 2007 registered nurses suffered 8,580 musculoskeletal disorders (MSDs) requiring days away from work, the seventh highest number of MSDs in the country, while nursing aides, orderlies, and attendants suffered 24,340 MSDs, the second highest number (Table 1-3). Astoundingly, the rate of injuries for nursing aides, orderlies, and attendants as a group (252 MSDs per 10,000 workers) was the highest rate of MSDs for any occupation, more than seven times the national MSD average.<sup>17</sup>

Researchers have found that 81 percent of nurses are affected by MSDs.<sup>18</sup> As significant as the existing injury data appears for patient caregivers, many musculoskeletal patient handling injuries are not reported<sup>19</sup>—according to some estimates, at least 50 percent.<sup>20</sup> Because of this, we are not aware of the true extent of caregiver injury or the consequences for patient care. That nurses often work when injured increases the risk of further injury to them and, in turn, the likelihood they will have to take leave or retire because of injuries.

Research has been conducted in various patient care environments<sup>21, 22, 23, 24, 25</sup> to identify manual PHAM tasks that put caregivers at most risk for injury, and findings confirm that these "high-risk" patient handling tasks place excessive biomechanical and postural stress on the musculoskeletal system of caregivers.<sup>26</sup> Listed in the accompanying sidebar are some, but certainly not all, PHAM tasks that are high risk when performed manually. For a list of high-risk tasks by clinical area, see Appendix A.

The level of risk in already high-risk tasks can be increased by their frequency and duration; the patient's size, weight, level of cooperation, and unpredictability; transfer distance; space constraints; awkward positions; and the avail-

## High-Risk Tasks Included in VA Patient Care Ergonomic Guidelines

- Transfer of patients to and from bed to chair, chair to toilet, chair to chair, or car to chair
- Lateral transfer of patients to and from bed to stretcher or trolley
- Transfer of patients to and from chair to stretcher, chair to chair, or chair to exam table
- Repositioning of patients in bed, both side to side and up in bed
- Repositioning patients in wheelchair or dependency chair
- Transfer of patients up from the floor
- Tasks requiring sustained holding of limb(s) or access to body parts of bariatric patients
- Transporting bariatric patients (stretcher, wheelchair, walker)
- Bariatric toileting tasks

Source: *Patient Care Ergonomics Resource Guide: Safe Patient Handling and Movement* (Tampa: Veterans Administration Patient Safety Center of Inquiry, 2001); [www.visn8.va.gov/PatientSafetyCenter/safePtHandling](http://www.visn8.va.gov/PatientSafetyCenter/safePtHandling).

ability of technology to reduce the risk.<sup>27</sup> The physical and medical conditions of the patient also affect the risk of caregiver injury (e.g., in the behavioral health setting, constraints upon PHAM equipment are necessary to provide a safe environment for suicide-risk patients).

### Impact on the Quality of Patient Care

The goal of a health care organization is to initiate the healing process for patients and to provide a comfortable and pleasant environment of care. Caregivers know that manual patient handling affects these goals, but only limited hospital data is available that directly connects manual handling to adverse patient events.<sup>33</sup> However, anecdotal stories tell of the dislodgement of invasive tubes and lines, dislocation of shoulders, fracture of fragile bones, and patients dropped during manual patient handling.<sup>34</sup> As well, skin tears and abrasion are common when patients are pulled up and across beds, and manual patient handling has been related to pain in critically ill patients. Reports by critically ill patients 18 years and older noted that pain experienced during turning/repositioning activities was greater than during tracheal suctioning, tube advancement, and wound dressing changes.<sup>35</sup>

## Safe Patient Handling and Movement Guidelines, Legislation, and Regulations

Over the past decade, a variety of entities have turned their attention to the issue of safe patient handling and movement. Professional health care groups, labor organizations, the health care industry, regulatory agencies, and the scientific community have converged in attempts to arrive at effective solutions to protect direct patient caregivers from the ergonomic hazard of manual patient handling.

Regulating entities have taken stands against manual lifting and promoted safe patient handling techniques. Of all industries the U.S. Department of Labor Occupational Safety and Health Administration (OSHA) targeted for development of an ergonomic guideline, the health care industry was the first to receive one—“Guidelines for Nursing Homes: Ergonomics for the prevention of musculoskeletal disorders.”<sup>28</sup> In addition, OSHA identified “manual” patient handling as the primary cause of musculoskeletal disorders among patient caregivers. As a result, the OSHA guidelines explicitly recommend the use of assistive technology and note that the guidelines can be applied to other health care settings where patient care occurs.<sup>29</sup> The Joint Commission

instructed health care organizations to address ergonomic hazards related to patient handling by utilizing patient lift equipment and lateral transfer devices in compliance with its Environment of Care standard and by incorporating recognized best practices in their facilities.<sup>30, 31</sup>

The United Kingdom, Australia, and Canada instituted national “no lift” policies that banned the manual patient handling techniques many still embrace in the United States, instead mandating the use of assistive devices to move and lift patients.<sup>32</sup> As of this writing, nine U.S. states (Washington, Texas, Minnesota, Illinois, Rhode Island, Maryland, Ohio, New York, and New Jersey) have adopted legislation, and Hawaii passed a resolution. Legislation has been proposed at the national level, and support is growing.

For more information related to national policies and specifics of state legislation, see Appendix B. For the current status of state and federal legislation, link to the American Nurses Association Web site at <http://nursingworld.org/MainMenuCategories/OccupationalandEnvironmental/occupationalhealth/handlewithcare.aspx>.

Patient mobilization efforts are also affected negatively when manual means are the only or primary method for accomplishing this critical activity. The weight of evidence supports the positive effect of movement and mobilization on the quality and speed of a patient’s recovery and on the patient’s ability to preserve current levels of physical capability. Therefore, insufficient movement and mobilization puts patients at high risk of immobility-related adverse events (see the sidebar for some complications of patient immobility).<sup>36</sup>

Patients may also be affected indirectly when staff members work in pain and discomfort and/or under medication due to injuries incurred while manually handling patients. Unintentional errors may adversely affect patient care, and personnel shortages as a result of injuries cannot help but affect the quality of care patients receive. In addition, caring for patients with higher weights and acuity levels makes it even more difficult for overextended caregivers to find time to mobilize and transfer patients—activities that, as mentioned above, are critical to the healing process and prevention of patient deterioration.

## Current Patient Handling and Movement Equipment Categories

Fortunately, ergonomic interventions in the form of mechanical assistive technology are available to decrease the risks of manual patient handling and movement for both patients and caregivers. The PHAM equipment categories listed in Table 1-4 are common as of this writing. Although not all of these have marked effects on design decisions, the patient handling devices identified with an asterisk (\*) must be stored in accessible and appropriate locations, requiring thought to be given to storage space specifications. Furthermore, during use, this equipment takes up additional space in patient rooms and/or toilet rooms. To accommodate it, adequate space must be allowed for use by one or more caregivers (including a sufficient turning radius) in the bath, patient room, and hallway. Importantly, use of larger, bariatric variations of patient handling equipment is essential for protecting caregivers and patients.

For detailed descriptions of PHAM equipment, plus photographs, refer to Appendix C.



The sling selection chart<sup>38</sup> in Appendix D can be used to match patient handling tasks with appropriate slings used with powered patient lifting equipment.

The key implementation strategy for reducing the risk of staff injury and improving the quality of patient care and mobilization is replacement of manual patient handling with use of assistive PHAM equipment. Nonetheless, organizational and programmatic support structures must be in place to foster equipment use for this strategy to be successful.<sup>39</sup> Expecting caregivers to totally change the way they perform their work without such support structures often results in frustration and costly mistakes. Patient handling and movement programs (PHAMPs) that include knowledge transfer mechanisms and change strategies foster caregiver compliance with equipment use and ultimately improve the quality of patient care along with the workplace for caregivers.<sup>40</sup> Chapter 4 in this document provides a detailed discussion of PHAMPs and implementation strategies to reduce manual patient handling.

### Benefits of Patient Handling and Movement Technology

The quality of patient care, mobilization, rehabilitation, and quality of life and the risk to staff and patients from moving and handling patients are positively influenced by the use of PHAM technology. For this reason, design solutions that include patient handling equipment and storage allotments for equipment will foster improved patient care and outcomes as well as safer and more professionally satisfying work environments.

### Improving the Workplace and Reducing Risk of Injury

The development of PHAM equipment has substantially reduced the act of strict manual patient handling as an essential function of patient care. To better understand how use of such equipment can reduce the risk of caregiver musculoskeletal injury, note that PHAM equipment operates as engineering controls—methods of controlling exposure to hazards by modifying the source or reducing the amount of the hazard.<sup>41</sup>

### Some Complications of Patient Immobility<sup>37</sup>

A large number of complications are attributable to insufficient movement during the recovery process. Examples are listed here:

**Respiratory:** pneumonia

**Cardiovascular:** deep vein thrombosis (DVT), hypotension

**Gastrointestinal:** constipation

**Genitourinary:** urinary infection, incontinence

**Endocrine:** hyperglycemia, insulin resistance

**Metabolic:** altered pharmacokinetics (what the body does to a drug)

**Musculoskeletal:** deconditioning, bone demineralization, osteoporosis

**Skin:** pressure ulcers (bedsores)

**Psychosocial:** depression, decreased functional capacity, increased dependency

Robert L. Kane et al. *Essentials of Clinical Geriatrics*, 5th ed. New York: McGraw-Hill (2004), 245–48; and Rosemary A. Timmerman, “A mobility protocol for critically ill adults,” *Dimensions of Critical Care Nursing* 26, no. 5 (Sept.–Oct. 2007): 175–79.

### Table 1-4. Common Patient Handling and Movement Equipment, by Category

#### Powered Patient Lifting Equipment or Hoists

Full-body sling lifts

Overhead lifts (ceiling-mounted, wall-mounted, or portable lifts)

\*Floor-based sling lifts

\*Gantry lifts

\*Sit-to-stand (stand assist or standing) lifts

#### Lateral Transfer (Slide) Devices

Air-assisted lateral transfer devices

\*Mechanical lateral transfer devices

Friction-reducing devices (sliding boards, roller boards, slippery sheets, etc.)

#### Other Devices

\*Transfer chairs

Non-powered standing aids

Transfer boards/devices

Beds/mattresses

\*Stretchers/gurneys

\*Transport assistive devices

Engineering controls are the best line of defense for worker protection and can be effectively applied to patient handling. In patient handling, the hazard is the force imposed on the musculoskeletal system of the patient care provider.<sup>42</sup> PHAM equipment functions to reduce the injurious forces that result from performing a task, thus lessening the hazard to a level within the capabilities and limitations of the human body.

Here the concept of ergonomics comes into play. Those tasks that exceed the biomechanical capabilities of workers are ergonomic hazards, and they result in musculoskeletal injuries (acute and cumulative trauma). The goal of ergonomics is to modify the work environment and/or process to eliminate or decrease the impact on the musculoskeletal system. PHAM equipment takes the ergonomic load off of caregivers, keeping the work they do within their biomechanical limits. (See the sidebar on the biomechanics of patient handling injuries.)

A number of researchers have conducted trials using safe patient handling programs that include PHAM equipment as the key risk reduction element; their results have shown great success in reducing staff injuries and resultant lost work time and modified duty days.<sup>43, 44, 45, 46</sup> Data on job satisfaction showed increased feelings of professional status and decreases in task requirements. Such positive outcomes were thought to improve nursing retention and have a positive effect on nursing recruitment.<sup>47</sup>

### **Improving the Quality of Care**

Assistive PHAM technology has raised the quality of nursing care provided when compared to care provided using manual lifting techniques. Mechanical lifting equipment and other assistive devices provide a more secure process for lifting, transferring, repositioning, and mobilization tasks, particularly for geriatric populations. This may be why caregivers comment that use of PHAM technology lessens patient anxiety and enhances patient dignity and autonomy. In addition, the potential for patient injury (e.g., skin tears, joint dislocations, falls) as a consequence of manual patient handling is reduced.<sup>48</sup> In a white paper on patient handling and patient care, the American Physical Therapy Association

(APTA) supports the use of PHAM technology to decrease risk for both staff and patients.<sup>49</sup>

Research on patient outcomes related to the use of safe patient handling techniques and technology is limited: A multitude of variables within a health care environment (e.g., unique patient characteristics and medical conditions, patient care environment factors, and staffing levels) make a direct causal relationship difficult to establish. However, several studies show relationships between the use of certain types of patient handling equipment and improvements in patient outcomes. For instance, a hospital-based study comparing skin tears before and after institution of procedures involving use of ceiling lifts with repositioning sheets/slings found reduced tissue viability risk and reduced cross-infection risk.<sup>50</sup> Another study found a relationship between the use of PHAM equipment and residents' lower depression scores, improved urinary continence, decreased likelihood of falling, engagement in more activities, and greater alertness during the day.<sup>51</sup> Researchers have observed a link between the use of lifting equipment and decreases in the combative behavior of residents with dementia.<sup>52, 53</sup> In addition, much anecdotal information directly ties use of patient handling equipment to increases in the quality of care and quality of life in residential settings. Many stories relate positive outcomes such as decreases in pain, increases in dignity, and improvement in continence when PHAM equipment is used.<sup>54</sup>

### **Design Considerations in the Provision of Safe Patient Care Environments**

As we have seen, the use of PHAM technology can positively influence quality of patient care, degree of mobilization and rehabilitation, quality of life, and level of risk to staff and patients from moving and handling patients. Architecture and design that take into account patient handling equipment, adequate space for safe patient handling, and storage allowances for equipment will foster improved patient care and outcomes as well as safer and more professionally satisfying work environments for staff. By extension, functional

spaces that do not take these factors into account make it much more difficult for health care organizations to implement safe patient handling measures.

To date, design professionals have been at a disadvantage that this white paper aims to address—a lack of knowledge about PHAM technology. Patient handling equipment and its design parameters are new to many design professionals in the United States; consequently, they have had no consensus standards or master specifications to follow and depended on the word and expertise of manufacturers and the limited design recommendations currently available.<sup>55, 56, 57, 58</sup> Those who are familiar with safe patient handling may be reluctant to suggest inclusion of patient handling technology to their clients due to the associated costs. On the other hand, they may be hesitant not to suggest it, given the increasing focus on the provision of minimal manual lift patient care environments that is reflected in state and federal

legislative efforts, strides by government agencies such as the Veterans Health Administration, and support from the American Nurses Association, American Physical Therapy Association, Association of periOperative Registered Nurses, National Association of Orthopaedic Nurses, and other clinical organizations.

A number of design/architectural features must be addressed in this context. They are discussed in more detail in Chapter 2 and include:

- Flooring materials and finishes
- Space constraints
- Storage space
- Door openings
- Hallway widths
- Floor/walkway slopes and thresholds
- Elevator dimensions
- Headwalls and service utility columns/systems
- Weight capacities of toilets and mounted objects

## Caregiver Stories from the Field

These stories were collected by Lisa Murphy, RN, BA, BSN, who is nursing service collateral duty safety officer/SPH facility coordinator at Jesse Brown VA Medical Center in Chicago.

**Rehab medicine.** The physical therapist utilized an ambulation sling with ceiling lift for a patient who was rehabilitating after a stroke. The sling removed the fear factor for gait training, and the patient progressed much faster and, in fact, did not want to stop his therapy. This patient, who was initially not walking, eventually went home climbing stairs with a cane.

**Oncology unit.** A patient came in so weak that a full-body sling lift was required to place him in a chair. After a couple of days, he asked staff to stand him up, so they utilized a sit-to-stand lift. After using it, the patient would not use the full-body sling lift and requested the sit-to-stand lift often because he liked being up out of the wheelchair. He eventually went home with a walker because he was able to gain strength using the sit-to-stand lift.

**Surgery unit.** During an equipment trial, a non-powered sit-to-stand lift was used to assist a patient around his room and into a wheelchair.

He said it helped him build strength in his arms and legs and asked if he could help train other staff in its use while he was there.

**Intensive care unit.** A bariatric surgery patient asked to use the sit-to-stand lift for ambulation as it gave him a greater sense of security when he first got up after surgery.

**Oncology unit.** An air-assisted lateral transfer mattress was used to take an older, frail, very tall patient for a CT scan. When the CT was done and the patient returned to the unit, he asked if he could use the air mattress again. (Patients and staff really like the air mattresses, which feel much better to patients than being pulled on something thin over bumps in procedural tables.)

**Nursing home.** A nursing home resident had severe contractures, making it extremely difficult for staff to place him in a chair; consequently, this resident was rarely moved out of bed, worsening not only his physical condition but also his quality of life. The situation improved after ceiling lifts were installed; almost every day thereafter, the resident was moved into a chair.

*Lisa Murphy, RN, BA, BSN*

### Flooring Materials and Finishes

Over the past several years, concern has been growing about work-related musculoskeletal injuries associated with the movement of patients and health care-related equipment on carpeted or padded tile surfaces. Such pushing and pulling may result in excessive shear forces on the spine; these forces become particularly problematic when performing turning maneuvers.<sup>59</sup> Increases in the shear forces to the spine are attributable to the difficulty in overcoming inertia when initially pushing or pulling a wheeled object,<sup>60</sup> surface resistance of the flooring material,<sup>61, 62</sup> wheel design and condition,<sup>63</sup> and the weight being pushed/pulled.<sup>64</sup> From a safe patient handling perspective, rolling lifts over carpeting or wood flooring compared with less resilient flooring materials is a factor to consider when specifying flooring materials.<sup>65</sup>

### Space Constraints

Understandably, health care organizations attempt to make the best use of available space, and—especially in older health care facilities with multiple-bed wards—“working” space is sometimes quite limited. However, moving rolling equipment in tight spaces compounds already difficult patient handling tasks.<sup>66, 67</sup> The effects of space constraints are readily observable when staff are seen performing patient care in awkward positions, or when necessary patient handling assistive devices cannot be used as a result of inadequate space in a patient room or toilet room. In certain room layouts, staff members need to physically relocate beds and other patient furniture every time they transfer a patient into a wheelchair or onto a stretcher. Nurses sometimes describe their jobs as “furniture movers.” Some rooms are so small that patients must be moved in their beds into the hallway or an adjacent room for a safe lateral transfer onto a stretcher.

Using floor-based patient handling equipment in small spaces such as a toilet room causes shear forces on the spine that are significantly greater than those caused by simply pushing portable equipment in adequate spaces.<sup>68, 69</sup> These findings for portable lifting equipment may be extrapolated to pushing/pulling other types of equipment, such as beds, patient room furniture,

and other objects found in a patient room. When caregivers must continually move items to provide proper patient handling, their risk of injury is compounded. As well, awkward postures resulting from lifting and moving patients in small spaces increase the risk of injury. Adequate space will enhance the quality of nursing by facilitating mobilization of patients, reducing strain-related injuries to staff, and increasing staff productivity.<sup>70</sup>

### Storage Space

Inadequate storage space is universally problematic in health care facilities. The more patient rooms, the more revenue for the facility, and thus storage areas are often among the first spaces to be decreased or eliminated when design cost constraints arise. In addition, the numbers and types of equipment (including patient handling equipment) requiring storage space in clinical areas have increased. With OSHA and National Fire Protection Association (NFPA) regulations that prevent storage in hallways for life safety purposes, storage rooms are often filled to the brim. Limited and inaccessible storage space for mobile patient handling equipment significantly affects staff compliance with safe patient handling techniques.<sup>71</sup> If staff must take time to walk down the hall, sometimes quite a distance, to a storage room filled with other equipment and move that other equipment to access a lift, caregivers often opt instead to transfer patients manually.

### Door Openings

Insufficient doorway dimensions can prevent use of mobile patient handling lifts and other rolling equipment. Scraped knuckles and abrasions on the upper arms of staff can result from pushing beds and equipment through doorways that are too narrow. Simple entry and exit, especially in emergency situations involving bariatric beds, are problematic in many health care facilities. It is not uncommon for morbidly obese and bariatric patients to receive treatments and procedures in their rooms rather than in a designated treatment or procedure area because their patient bed or equipment is too large to pass through the doorway.

### Hallway Widths

Narrow hallways can add another level of difficulty to moving patients and equipment. An inadequate turning radius in a hallway creates an unsafe situation in which staff must push a heavy bed sideways in order to turn sharply around a corner or into a patient room.

### Floor/Walkway Slopes and Thresholds

Hospitals are filled with rolling equipment, yet high to medium thresholds abound, making it difficult for staff to use rolling equipment and unsafe for patients moving themselves or being moved. Pushing patients up and down inclines in beds or wheelchairs has the potential for causing serious injury to both patient and caregiver.

### Elevator Dimensions

The interior dimensions of elevators may prevent the use of certain types of high-tech and bariatric beds.

### Headwalls/Service Utility Columns

Headwall and service utility column/system designs can promote or interfere with the installation and use of overhead lifts—especially traverse track systems. This is particularly problematic in very high-risk patient handling areas such as ICUs, where 100 percent ceiling lift installation is recommended.<sup>72</sup> If they are not ergonomically designed, these structures can also limit easy access to patients and items required for care.

### Weight Capacities of Toilets and Mounted Objects

When care for morbidly obese and bariatric patients and visitors is provided or anticipated, the weight capacities of toilets, chairs, handrails, sinks, grab bars, and other mounted objects in patient rooms, toilet rooms, hallways, shower rooms, waiting rooms, and elsewhere must be taken into consideration to avoid serious injuries.

### Endnotes

- 1 P. French, L. F. W. Flora, L. S. Ping, L. K. Bo & W. H. Y. Rita, "The prevalence and cause of occupational back pain in Hong Kong registered nurses," *Journal of Advanced Nursing* 26 (1997): 380–88.
- 2 U.S. Department of Labor, Bureau of Labor Statistics, *Survey of occupational inquiries and illnesses, 2001* (Bureau of Labor Statistics: Washington, DC, December 19, 2002).
- 3 B. D. Owen, "Preventing injuries using an ergonomic approach," *Association of periOperative Registered Nurses Journal* 72, no. 6 (2000): 1031–36.
- 4 B. D. Owen & A. Garg, "Reducing back stress through an ergonomic approach: Weighing a patient," *International Journal of Nursing Studies* 31, no. 6 (1994): 511–19.
- 5 A. Garg & B. Owen., "Prevention of back injuries in healthcare workers," *International Journal of Industrial Ergonomics* 14 (1994): 315–31.
- 6 M. S. Rice, S. M. Woolley & T. R. Waters, "Comparison of required operating forces between floor-based and overhead-mounted patient lifting devices," *Ergonomics* 52, no. 1 (2009): 112–20.
- 7 W. S. Marras, G. G. Knapik & S. Ferguson, "Lumbar spine forces during manoeuvring of ceiling-based and floor-based patient transfer devices," *Ergonomics* 52, no. 3 (2009): 384–97.
- 8 A. L. Nelson, J. Lloyd, N. Menzel & C. Gross, "Preventing nursing back injuries: Redesigning patient handling tasks," *AAOHN Journal* 51, no. 3 (2003): 126–34.
- 9 T. R. Waters, "When is it safe to manually lift a patient?," *American Journal of Nursing* 107, no. 6 (2007): 40–45.
- 10 M. Matz, "Understanding hazards and controls in health care," in *Working Safely in Health Care: A Practical Guide*, ed. D. Fell-Carlson (New York: Delmar Thomson Learning Publishing Company, 2007).
- 11 Waters, "When is it safe to manually lift a patient?"
- 12 W. S. Marras, "Occupational low back disorder causation and control," *Ergonomics* 43, no. 7 (2000): 880–902.
- 13 T. Waters, "Science to support specific limits on lifting, pushing, and pulling and static postures" (Presentation at the 8th Annual Safe Patient Handling Conference, Lake Buena Vista, Florida, March 2008).
- 14 Marras, "Occupational low back disorder causation."
- 15 Ibid.
- 16 Ibid.
- 17 U.S. Department of Labor, Bureau of Labor Statistics, *Survey of occupational injuries and illnesses* (Washington, DC: Bureau of Labor Statistics, October 16, 2007). Retrieved from www.bls.gov.
- 18 P. French et al., "The prevalence and cause of occupational back pain in Hong Kong registered nurses."
- 19 Occupational Health & Safety Agency for Healthcare (OHSAH) in British Columbia, *Ceiling lifts as an intervention to reduce the risk of patient handling injuries: A literature review* (Vancouver, BC: OHSAH, 2006). Retrieved on 8/20/09 from [http://control.ohsah.bc.ca/media/Ceiling\\_Lift\\_Review.pdf#search=%22b%20owen%2C%20patient%20lifts%20ratio%22](http://control.ohsah.bc.ca/media/Ceiling_Lift_Review.pdf#search=%22b%20owen%2C%20patient%20lifts%20ratio%22).
- 20 K. Siddharthan, M. Hodgson, D. Rosenberg, D. Haiduven & A. Nelson, "Under-reporting of work-related musculoskeletal disorders in the Veterans Administration," *International Journal of Health Care Quality Assurance Incorporating Leadership in Health Services* 19, nos. 6–7 (2006): 463–76.
- 21 A. Nelson, unpublished research data from pilot study (Tampa: James A. Haley VA Medical Center, 1996).
- 22 A. L. Nelson & G. Fragala, "Equipment for safe patient handling and movement," in *Back Injury among Healthcare Workers*, eds. W. Charney & A. Hudson (Washington, DC: Lewis Publishers, 2004), 121–35.
- 23 B. Owen & A. Garg, "Assistive devices for use with patient handling tasks," in *Advances in Industrial Ergonomics and Safety*, ed. B. Das (Philadelphia, PA: Taylor & Francis, 1990).
- 24 C. A. Sedlak, M. O. Doheny, A. Nelson & T. R. Waters, "Development of the National Association of Orthopaedic Nurses guidance statement on safe patient handling and movement in the orthopaedic setting," *Orthopaedic Nursing*, Supplement to 28, no. 25 (2009): 2–8.
- 25 AORN Workplace Safety Taskforce, *Safe Patient Handling and Movement in the Perioperative Setting* (Denver, CO: Association of periOperative Registered Nurses [AORN], 2007).
- 26 Nelson et al., "Preventing nursing back injuries."

- 27 Ibid.
- 28 U.S. Department of Labor, Occupational Safety & Health Administration (OSHA), *Guidelines for Nursing Homes* (Washington, DC: OSHA, 2002). Retrieved on 10/9/09 from [http://www.osha.gov/ergonomics/guidelines/nursinghome/final\\_nh\\_guidelines.html](http://www.osha.gov/ergonomics/guidelines/nursinghome/final_nh_guidelines.html).
- 29 U.S. Department of Labor, *Guidelines for Nursing Homes*. Retrieved on 10/9/09 from [http://www.osha.gov/ergonomics/guidelines/nursinghome/final\\_nh\\_guidelines.html](http://www.osha.gov/ergonomics/guidelines/nursinghome/final_nh_guidelines.html)
- 30 Joint Commission on the Accreditation of Healthcare Organizations, "Worker safety: Back injuries among health care workers in acute care settings," *Environment of Care News* 7, no. 6 (2004).
- 31 Joint Commission on the Accreditation of Healthcare Organizations, "Worker safety: Reducing the rate of back injuries among health care workers," *Environment of Care News* 7, no. 7 (2004).
- 32 J. Collins, "Safe lifting policies," in *Handle with Care: Safe Patient Handling and Movement*, ed. A. L. Nelson (New York: Springer Publishing Company, 2006).
- 33 A. Hudson, "Back Injury Prevention in Health Care," in *Handbook of Modern Hospital Safety*, 2nd ed., ed. W. Charney (New York: CRC Press, Taylor & Francis Group, 2010).
- 34 Hudson, "Back Injury Prevention."
- 35 Ibid.
- 36 Robert L. Kane, Joseph G. Ouslander, Itamar B. Abrass, *Essentials of Clinical Geriatrics*, 5th ed. (New York: McGraw-Hill, 2004), 245–48; Rosemary A. Timmerman, "A mobility protocol for critically ill adults," *Dimensions of Critical Care Nursing* 26, no. 5 (Sept.-Oct. 2007): 175–79.
- 37 Ibid.
- 38 A. Baptiste, M. McCleery, M. Matz & C. Evitt, "Evaluation of sling use for patient safety," *Rehabilitation Nursing* (Jan.–Feb. 2008).
- 39 A. L. Nelson, M. Matz, F. Chen, K. Siddharthan, J. Lloyd & G. Fragala, "Development and evaluation of a multifaceted ergonomics program to prevent injuries associated with patient handling tasks," *Journal of International Nursing Studies* 43 (2006): 717–33.
- 40 Nelson et al., "Development and Evaluation of a Multifaceted Ergonomics Program."
- 41 B. Plog, J. Niland & P. Quinlan, eds., *Fundamentals of industrial hygiene, 4th ed.* (Itasca, IL: National Safety Council, 1996).
- 42 A. B. de Castro, "Handle with care: The American Nurses Association's Campaign to address work-related musculoskeletal disorders," *Online Journal of Issues in Nursing*, 9, no. 3 (2004): 3.
- 43 Nelson et al., "Development and Evaluation of a Multifaceted Ergonomics Program."
- 44 J. W. Collins, L. Wolf, J. Bell & B. Evanoff, "An evaluation of a 'best practices' musculoskeletal injury prevention program in nursing homes," *Injury Prevention* 10 (2004): 206–11.
- 45 B. Evanoff, L. Wolf, E. Aton, J. Canos & J. Collins, "Reduction in injury rates in nursing personnel through introduction of mechanical lifts in the workplace," *American Journal of Industrial Medicine* 44 (2003): 451–57.
- 46 A. Nelson & A. Baptiste, "Evidence-based practices for safe patient handling and movement," *Nursing World / Online Journal of Issues in Nursing*, 9, no. 3 (2004): 4.
- 47 Nelson et al., "Development and Evaluation of a Multifaceted Ergonomics Program."
- 48 de Castro, "Handle with care."
- 49 American Physical Therapy Association (APTA), "Strategies to improve patient and health care provider safety in patient handling and movement tasks: A collaborative effort of the American Physical Therapy Association, Association of Rehabilitation Nurses, and Veterans Health Administration," *PT Magazine* (April 2005). Retrieved on 10/9/09 from <http://www.apta.org/AM/Template.cfm?Section=Home&CONTENTID=18516&TEMPLATE=/CM/HTMLDisplay.cfm>.
- 50 Heather Kirton, "Helping make 1:1 care mean 1:1 care!" (Poster presentation at the 8th Safe Patient Handling and Movement Conference, Lake Buena Vista, Florida, March 11–13, 2008).
- 51 A. L. Nelson, J. Collins, T. Waters, K. Siddharthan & M. Matz, "Link between safe patient handling and quality of care," *Rehabilitation Nursing* 33, no. 1 (2008): 33–41.
- 52 Collins et al., "An evaluation of a 'best practices' musculoskeletal injury prevention program."
- 53 B. Owen & A. Garg, "Reducing risk for back pain in nursing personnel," *AAOHN Journal* 39, no. 1 (1991): 24–33.
- 54 Nelson et al., "Development and Evaluation of a Multifaceted Ergonomics Program."
- 55 ARJO, *Guidebook for Architects and Planners*, 2nd ed. (ARJO Hospital Equipment AB, 2005).
- 56 S. Hignett, "Determining the space needed to operate a mobile and an overhead patient hoist," *Professional Nurse* 20, no. 7 (2005): 39–42.
- 57 M. Muir & L. Haney, "Designing space for the bariatric resident," *Nursing Homes/Long Term Care Management* (November 2004): 25–28.
- 58 J. Villeneuve, "Physical Environment for Provision of Nursing Care: Design for Safe Patient Handling" in A.L. Nelson, ed., *Handle with Care: Safe Patient Handling and Movement* (New York: Springer Publishing Company, 2006).
- 59 Marras et al., "Lumbar spine forces."
- 60 AORN Workplace Safety Taskforce, *Safe Patient Handling and Movement in the Perioperative Setting* (Denver, CO: Association of periOperative Registered Nurses [AORN], 2007).
- 61 Marras et al., "Lumbar spine forces."
- 62 Rice et al., "Comparison of required operating forces."
- 63 Ibid.
- 64 Ibid.
- 65 Ibid.
- 66 Marras et al., "Lumbar spine forces."
- 67 Rice et al., "Comparison of required operating forces."
- 68 Marras et al., "Lumbar spine forces."
- 69 Rice et al., "Comparison of required operating forces."
- 70 Muir, "Designing space for the bariatric resident."
- 71 M. Matz, "Analysis of VA patient handling and movement injuries and preventive programs" (Internal VHA report to Director, VHA, Occupational Health Program, 2007). Retrieved on 10/9/09 from [http://www.visn8.med.va.gov/PatientSafetyCenter/safePtHandling/Analysis\\_VAPtHndlgInjuries.doc](http://www.visn8.med.va.gov/PatientSafetyCenter/safePtHandling/Analysis_VAPtHndlgInjuries.doc).
- 72 M. Matz, "Patient handling (lifting) equipment coverage & space recommendations" (Internal VHA document presented to Director, VHA, Occupational Health Program, 2007).

# CHAPTER 2

## Explanation of PHAMA Components

### *Principal authors:*

MARY W. MATZ, MSPH, CPE AND GAIUS G. NELSON, RA

### *Contributing authors:*

DAVID M. SINE, MBE, CSP, ARM, CPHRM; JANE ROHDE, AIA, FIIDA, ACHA, AAHID, LEED AP;

MARTIN H. COHEN, FAIA, FACHA; ROGER LEIB, AIA, ACHA; DAVID GREEN;

JUDENE BARTLEY, MS, MPH, CIC; JAMES W. HARRELL, AIA, ACHA

A patient handling and movement assessment (PHAMA) is conducted to direct and assist the design team in incorporating appropriate patient handling and movement (PHAM) equipment into the health care environment. Such equipment serves to increase or maintain patient mobility, independent functioning, and strength as well as to provide a safe environment of care for staff and patients during performance of high-risk PHAM tasks. Both bariatric and non-bariatric patient care are addressed in a PHAMA.

The medical and physical characteristics of patient populations vary from one patient or resident care area to another, as do the environmental and space characteristics of the different locations. For this reason, PHAM equipment recommendations should be developed for each distinct unit and clinical area undergoing new construction or renovation. This will ensure that the type, size, weight capacity, and quantity of equipment available in each location are optimal for that location and that sufficient storage is allocated close to the point of use for such equipment.

A PHAMA should be conducted for all areas where patient handling and movement occurs and in any associated toileting, bathing, and showering areas. These areas include but are not limited to these:

- Medical/surgical units
- Rehabilitation units
- Critical care units
- Dialysis units
- Pediatric units
- Labor/delivery, antepartum, postpartum units
- Emergency department/urgent care
- Perioperative areas

- Outpatient/primary care clinics
- Nursing facilities/long term care units
- Spinal cord injury/TBI units
- Diagnostic areas
- Treatment areas
- Procedure areas
- Morgue
- Patient entrances, ambulance bays, reception areas, and admitting units

The PHAMA should be conducted by a multidisciplinary team that, at minimum, includes the following:

- Unit/area nurse manager/supervisor
- Unit/area peer leaders
- Frontline staff
- Risk management, safety, and/or ergonomics staff
- Facility design/construction staff
- Rehabilitative/therapy staff
- Infection control staff
- Housekeeping staff
- Maintenance staff
- Design team representative

Note that a PHAMA does not provide direction for conducting a full patient care ergonomic (PCE) evaluation, which is important to determine the PHAM technology needed to implement a true “minimal lift” policy and to identify other issues affecting equipment introduction and use. Note also that the information given here focuses on design and storage requirements for PHAM equipment currently in use that has significant implications for building design and construction (e.g., ceiling lifts, floor-based lifts, beds, and gurneys). It is highly recommended that a thorough PCE evaluation be conducted to identify other relevant PHAM technology and program-

matic issues related to patient handling and assistance. See Appendix E for steps in conducting a comprehensive PCE evaluation.

### **PHAMA Text in the 2010 Guidelines**

The information below explains the PHAMA requirements and information found in Section 1.2-5 and its related appendix in the 2010 edition of the *Guidelines for Design and Construction of Health Care Facilities*. All italicized text is taken verbatim from the 2010 Guidelines.

*The PHAMA has two distinct yet interdependent phases. The first phase includes a patient handling needs assessment to identify appropriate patient handling and patient movement equipment for each service area in which patient handling and movement occurs. The second phase includes definition of space requirements and structural and other design considerations to accommodate incorporation of such patient handling and movement equipment.*

#### **1.2-5.2.1 Phase 1: Patient Handling and Movement Needs Assessment**

*Evaluation of patient/resident handling and movement needs shall include, but not be limited to, the following considerations:*

##### **1.2-5.2.1.1 Patient handling and movement equipment recommendations, based on the following:**

###### *(1) Characteristics of projected patient populations*

PHAM equipment recommendations are based on the medical and physical characteristics—actual as well as potential—of the patient populations of each clinical area or unit. Particularly critical to determining the quantity and types of equipment necessary for each location are the average dependency levels of the patient population. To simplify this determination, patients are grouped in categories based on their physical limitations rather than their clinical acuity. Categories include total dependence, extensive assistance, limited assistance, supervision, and independent.<sup>1</sup> (Please refer to Table H-1: Physical Dependency Levels of Patient Population, in Appendix H, for definitions.)

Consideration of obese/bariatric patient weight and size is also important to ensure appropriate equipment weight capacities and dimensions are provided.

###### *(2) Types of high-risk patient handling and movement tasks to be performed and accommodated*

Equipment decisions are also based on the types of high-risk PHAM assistance performed. High-risk patient handling tasks demand moves, lifts, and other assistance that without technology would place excessive biomechanical and postural stress on the musculoskeletal systems of caregivers and pose risk of injury to patients. Researchers have identified many such high-risk tasks in various patient care environments<sup>2, 3, 4</sup> (see Appendix A), but some high-risk tasks do not currently have technology solutions to make them less ergonomically stressful. High-risk PHAM tasks for which equipment is available to minimize risk include but are not limited to the following:

- Vertical lifts/transfers (from/to bed/chair/commode/toilet/wheelchair/car)
- Lateral transfers (from/to bed/stretchergurney/trolley)
- Positioning/repositioning in bed (side to side, up to the head of the bed)
- Repositioning in chair/wheelchair/dependency chair
- Showering/bathing
- Toileting
- Dressing/undressing/changing diapers
- Wound care
- Lifting appendages
- Transporting patients
- Ambulating patients

The best source for identifying high-risk tasks performed on each unit is unit staff members who perform these tasks on a regular basis. Therefore, the PHAMA process should include:

- Interviews of frontline staff. Ask what tasks staff members perceive as presenting a high risk of injury for themselves and/or their patients, what they estimate to be the percentage of patients at each dependency level, what PHAM strategies are in place, and what present technology solutions are avail-



able and in use. (See Appendix F: Patient Care Ergonomic Evaluation Staff Interview Template.)

- Surveys of frontline staff. This is another tool for collecting information on staff perceptions of high-risk tasks. (See Tool 1, Perception of High-Risk Task Survey, in Appendix H.)

Patient handling injury data for each clinical unit/area are also a source of information for the high-risk tasks in that location. Tool 2, Unit/Area Incident/Injury Profile, in Appendix H offers a template for collection and analysis of unit/area patient handling injuries. However, this source should never be used in isolation as injuries are often not reported, which means important information may be missing from the data.

*(3) Knowledge of specific technology appropriate to reduce risk for each high-risk task*

Many, many types of PHAM equipment are available to reduce risk from the variety of high-risk tasks encountered in contemporary health care environments. Presently, equipment that influences design includes but is not limited to the following:

- Lifting/transferring equipment (portable/floor-based and fixed/ceiling or wall-mounted)
- Bathing/shower chairs and tubs
- Beds/stretchers/trolleys/gurneys
- Wheelchairs, dependency chairs
- Transfer chairs
- Mechanical lateral transfer devices

Since most of these devices are movable, planners must recognize the need for sufficient space for proper storage, movement, and use of the equipment and accessories. New equipment designs should be evaluated for their impact on building design as they become available.

A patient care ergonomic (PCE) evaluation process (Appendix E), mentioned above, will pull together the preceding information and facilitate accurate PHAM equipment purchase decisions, which will affect design decisions. Remember that it is important to conduct this evaluation in *all* areas where patient handling occurs.

Remember also that it is imperative to have staff input in the PHAM technology selection

process. Those unit staff members who assist patients in moving, transferring, and mobilization activities day in and day out are the best evaluators of different specific solutions and technologies. Not only do they know what equipment will meet the needs of their patients, but, as users of the equipment, they can best judge the “user-friendliness” of each variety of assistive technology.

Equipment trials and equipment fairs provide staff—including maintenance and housekeeping staff—the opportunity to judge equipment from their unique perspectives prior to purchase. During such trials, it is recommended that staff and others complete equipment evaluation surveys. These surveys should then be collated by clinical unit/area to ensure the appropriate equipment is selected for each unit/area. The survey information also should be used to determine specific manufacturers for inclusion in the bidding process. For more information, see Appendix G: Equipment Evaluation and Selection Process, which covers equipment trials and fairs.

When considering which manufacturers or vendors to use, keep in mind that if all ceiling lifts in a facility come from a single manufacturer, staff members are more likely to become competent in their use. In addition to being basic to safety, staff competency increases equipment use. In addition, sourcing from different manufacturers may affect costs and ancillary equipment needs as most slings, hanger bars, and accessories are not interchangeable from manufacturer to manufacturer, although it is possible to stipulate that competitive equipment have some interfacing protocols.

*1.2-5.2.1.2 Types of patient handling and movement equipment to be utilized (manual or power-assisted fixed ceiling or wall-mounted lifts, manual or power-assisted portable/floor-mounted lifts, electric height-adjustable beds, or a combination thereof)*

Refer to Appendix C and Appendix D for a discussion of the characteristics and merits of different PHAM equipment solutions.

After recommendations for specific equipment types have been developed for a unit or area, the unique features required for installing and/or

using the recommended equipment should be determined. These features are based on the results of the ergonomic and structural evaluations for the area (see Appendix E: Patient Care Ergonomic Evaluation Process, and Appendix H: Clinical Unit/Area Characteristics/Ergonomic Issues).

Much research identifies ceiling lifts as the preferred, currently available solution for patient care environments,<sup>5, 6, 7, 8, 9, 10, 11, 12, 13</sup> although existing building configuration and structural issues may necessitate the use of floor-based lifts. In addition, some clinical areas require special consideration regarding the type and style of equipment to be introduced. For instance, the more homelike environments in long-term care settings encourage consideration of ceiling lifts and track systems that blend in with the décor of the room. In behavioral health settings, other critical concerns affect equipment selection and storage options, as noted in the accompanying sidebar.

### *1.2-5.2.1.3 Quantity of each type of patient handling and movement equipment needed for each area under consideration*

The patient care ergonomic (PCE) evaluation process (Appendix E) helps determine the

quantity of each type of PHAM equipment needed for each area under consideration. Methods for determining appropriate lift coverage for clinical units/areas are found in Appendix I: Ceiling-Lift Coverage Recommendations by Clinical Unit/Clinical Area and Appendix J: Floor-Based Lifts Coverage Determination.

When calculating quantities for different types of equipment needed in each unit/area, be sure to factor in any existing equipment already in use. An equipment log, such as one found in Appendix H (Tool 3), can keep track of existing equipment as well as new equipment introduced into the unit/area. Since the log also captures the estimated percentage of time each piece of equipment is used, it will highlight the need for staff retraining on equipment use and should help with decisions about whether to acquire more equipment of the same type.

For units undergoing renovation or for new construction, consult with staff from existing units and/or staff who are aware of projected patient population characteristics. Staff members should be able to provide information on the quantity and types of existing equipment that will be transferred, if any, and/or assist in determining the need for new equipment.

## **Behavioral Health Settings**

Any equipment introduced into the environment of care of a behavioral health unit must be suitably tamper-resistant and compatible with other design choices intended to reduce/eliminate the availability of points of attachment and thus the risk of suicide/self injury.

However, the great variation in behavioral health patient populations means the risks from equipment (including non-platform beds) are fewer for some patient populations than others. Thus, while a ceiling lift for an acute adult behavioral health patient population is unacceptable, the risk may be sufficiently offset by the benefits to geri-psych patients and the staff that cares for them. Similarly, the benefits of a standard mechanized hospital bed on a medical psychiatric unit may allow for the use of portable patient lift equipment on that unit.

Ceiling lifts may be present in outpatient settings—crisis intervention centers; emergency,

urgent care, and some clinic settings where an observation bed may be needed; and therapy areas where lifts might be used to move patients onto or into an apparatus such as a tub. In such cases, behavioral patients must be kept under constant observation.

Portable lifting equipment that is moved in and out of the room is an alternative to the ceiling lift; however, the platform beds often found in such areas lie flat on the floor, eliminating the option of using portable lifts with bases that normally fit under a bed. Other types of PHAM equipment, such as inflatable devices that allow patients to be lifted from the floor and then transferred to an appropriate location, have been quite useful in these areas. However, such equipment types require sufficient space within the patient room, making room size an important consideration.

*David M. Sine, MBE, CSP, ARM, CPHRM*

#### **1.2-5.2.1.4 Required weight-carrying capacities**

Determine required weight-carrying capacities for each unit/area by reviewing facility and unit/area trends for obese and bariatric patients and by interviewing unit/area staff. Lift weight capacities range from around 350 lbs. to 1,000 lbs. or more for bariatric, expanded capacity lifts. Even though bariatric floor-based lifts are available, carefully consider their use; pushing/pulling such equipment, added to considerable patient weight, exerts a significant force on the caregiver's spine. Bariatric lifts also have a substantial footprint that must be considered when planning space needs for storage and use in patient rooms. Alternatives to bariatric floor-based lifts are ceiling lifts and gantry lifts (see Appendix C for more information). For ceiling lifts, lifts with a 500–600 lb. weight capacity will accommodate most patients. (Some obese patients can weigh 1,000 lbs. or more, however.) If bariatric admissions warrant, a minimum of one expanded capacity/bariatric ceiling lift per unit should be included, in addition to the lower weight capacity lifts.

#### **1.2-5.2.1.5 Locations/rooms/areas for use with installation requirements (if fixed) and/or storage requirements**

**Locations/rooms/areas for use:** Unit staff will be the best resource for determining which patient rooms require installation of ceiling lifts and use of other PHAM equipment. If 100 percent ceiling-lift coverage will not occur on a unit, caregivers should assist in identifying appropriate locations for installation of ceiling lifts and/or use of floor-based/portable lifts. Often ceiling-lift placement is based on the configuration of patient rooms and the number of beds within them, in order to cover the greatest number of patients with the fewest ceiling lifts. Room selection for ceiling lifts also may be based on placement of the sickest and most dependent patients, frequently near a nurse work station.

**Installation requirements for fixed lift systems:** A manufacturer's recommendations and instructions are the best sources for installation requirements; however, facility staff and others responsible for design/layout should work

closely with the lift manufacturer so the latter will be aware of building design factors that may affect installation and safe and easy use of equipment.

Considerations related to the selection and installation of ceiling-lift tracks (e.g., coverage, motorization, charging, design, and fastening) are discussed in Appendix K: Design/Layout Considerations for Ceiling/Overhead Lift Tracks.

**Storage requirements:** Unit staff will be best able to determine the most advantageous storage locations for portable lifts, other PHAM equipment, and slings associated with lifts. A method for calculating storage space requirements for floor-based lifts is found in Appendix L: Storage Requirements. These calculations do not include aisle and access and other storage space needs.

In behavioral health settings, portable lifting and other equipment that is moved in and out of the room may be used; consequently, storage locations for PHAM devices should be easily accessible as well as lockable.

#### **1.2-5.2.2 Phase 2: Design Considerations**

*The impact of patient handling and movement needs on building design shall be addressed in the PHAMA, including consideration of both bariatric and non-bariatric patient needs. These design considerations shall incorporate results from Phase 1 and shall include, but are not limited to, the following:*

##### **1.2-5.2.2.1 Structural considerations to accommodate current and/or future use of patient handling and movement equipment**

Building plans should be reviewed by a structural engineer to determine if the structural capacity of the areas where ceiling lifts will be mounted is sufficient to support them. Installation/attachment methods for ceiling-lift tracks are included in Appendix K.

##### **1.2-5.2.2.2 Electrical and mechanical considerations for current and/or future use and/or installation of patient handling and movement equipment and associated storage and charging areas**

Building system design considerations for installation and use of PHAM equipment are of two

types: (1) electrical and ventilation needs for storage and charging of PHAM equipment and (2) placement of building system components so they do not interfere with operation and use of PHAM equipment.

Electrical requirements for use and storage of PHAM equipment depend on the equipment type and manufacturer. An electrical connection at a specific location is often all that is required, and usually a simple electrical supply is sufficient for charging ceiling-lift batteries. Some ceiling lift tracks have an electronic charging system (ECS), which enables the lift motor to be charged from contact with copper stripping present throughout the length of the track; these systems require planning during system design for the location(s) and type(s) of electrical connection(s), which must be identified in the construction documents.

Where required, area(s) with adequate electrical power must be provided to store and charge floor-based lifts and other PHAM equipment powered by batteries. In addition to code-compliant battery charging systems, such storage rooms may require air-conditioning and/or exhaust systems, depending on the types of batteries to be charged and whether noxious fumes are produced during the charging cycle.

Location of building system elements within the occupied environment (e.g., light fixtures, fire suppression sprinkler heads, HVAC diffusers and equipment, supports for cubicle curtain and IV suspension tracks)—as well as structural supports, conduits, pipes, and ducts associated with these elements—must be coordinated with space needed to properly install and operate PHAM equipment. Careful coordination of above-ceiling building system components and

## Patient Movement Destination Points

Development of a comprehensive PHAM system requires identification of the destination points to which patients will be moved. These destination points are of two types: (1) those used by staff to provide patient care and (2) those chosen by patients to permit their involvement in activities and relationships that are meaningful and important to them.

Determining the reasons for patient movement and the destinations to which patients are moved in a particular health care environment is an essential step in the PHAMA process. The resulting information is used to:

- Ascertain that appropriate PHAM technology is in place in all areas needed on both ends of a patient's transport.
- Develop a building design and select movement support technology that will encourage self-mobilization of the patient in order to maintain and improve patient functioning.
- Design a building layout that will increase staff efficiency by reducing turns and travel distances along routes to the most frequent destinations.
- Select floor coverings, locate handrails, and define rest areas that encourage patient self-mobilization by reducing fear of falling.

Patient movement involving destination points includes both patient transport carried out by staff members and patient mobilization without staff assistance. It occurs within acute care,

ambulatory care, and long-term care settings. Starting points for acute care include the emergency department and the patient room. The primary starting point for long-term care settings is the patient/resident room. The starting point for ambulatory care is usually the patient examination or intake room.

### Emergency Department

After admission to an emergency department, a patient is usually stabilized, placed on a wheeled device, and transported to a destination for treatment. The device is typically a gurney or wheelchair. A patient may be taken to one of the following areas and may remain on the transport device or be transferred to another transport device at the destination.

- Medical/surgical unit—transferred to hospital bed or chair
- Critical care units—transferred onto a hospital bed
- Triage—remains on a gurney or in a wheelchair
- Examination areas, including:
  - Radiology, MRI, CT unit—transferred onto an integral treatment table or remains on a radiolucent gurney
  - Lab for blood draw and fluid sampling—likely remains on a gurney or in a wheelchair
- Surgical suites or procedure areas—transferred onto an operating table or special procedure chair

*sidebar continues on next page*

structural elements required by lifting systems can simplify installation and future maintenance of both. Adequate clearance must also be provided for operation of the lifting equipment.

**1.2-5.2.2.3 Adequate space for providing patient care and for maneuvering within and around areas where staff will use patient handling or movement equipment**

When high-risk PHAM tasks are performed in spaces that are too small, the risk of injury rises substantially. For this and numerous other reasons, bed space requirements for health care facilities have gradually increased over the years. Recently, five international publications recommended a minimum bed space width of 3.6 meters.<sup>14</sup> The following recommendations are intended to ensure the provision of adequate space for safe patient handling in the patient room and elsewhere:

- Throughout the facility, all open maneuvering areas should accommodate the expanded width of portable/floor-based lifts and other equipment such as standard and motorized beds/gurneys/stretchers.
- Bariatric patient rooms and associated toilet rooms should accommodate the expanded width of bariatric portable/floor-based lifts along with at least two to three staff members.<sup>15</sup>
- All maneuvering space for lifting apparatus should be as recommended by the equipment manufacturer or based on other special knowledge of the user and designer.

**Note:** Space provided adjacent to patient toilets in compliance with ADA and ANSI A117.1 code requirements may be inadequate for safe patient movement and handling. For further information, see Section 1.1-4.1 (Design Standards for the Disabled) in the 2010 Guidelines; refer especially to 1.1-4.1.3 (Special Needs in Health Care Facilities).

*sidebar continued from previous page*

### **Acute Care Patient Room**

In short-stay care facilities such as acute care hospitals and rehabilitation facilities, movement to the following destinations originates from the patient room. Such transport may be by wheelchair, gurney, or lift technology.

- Toilet
- Bathing/showering areas
- Higher- or lower-acuity patient rooms or patient discharge due to a change in acuity
- Diagnostic and testing areas for examination
- Procedural areas, suites, or labs (e.g., cath lab, GI lab, dialysis area, etc.)
- Surgical suites
- Encounter room and therapy areas for group support and therapy
- Lobby, cafeteria, vending machines, or outdoors for visiting, exercise, food, change of scenery
- Morgue

### **Long-Term Care Patient/Resident Room**

In long-stay patient facilities such as chronic care hospitals and skilled nursing facilities, the following activities may require transport by wheelchair or lift technology to a particular destination:

- Toileting—in a private or shared toilet adjacent to room

- Bathing/showering—in an adjacent private room or a shared facility
- Dining—in a shared dining area, three times a day
- Special interest activities—craft rooms, outdoors, kitchen, chapel, etc.
- Meetings with residents, family, friends, organizations—various size rooms and spaces
- Exercise—outdoors, exercise equipment room, group exercise space, pool, etc.
- Examination, treatment—special rooms and spaces
- Socialization—café, lounge, outdoors, corridors (by walking or assisted movement)
- Therapy—physical, occupational, speech therapy areas
- Hair and nail care—barber and beauty shop

### **Outpatient Facilities**

In ambulatory care settings, movement to some of the destinations listed below originates in a reception/waiting area, intake area, or examination/treatment room. Such transport may be by wheelchair, gurney, or lift technology.

- Toilet
- Diagnostic and testing areas
- Procedural areas, suites, or labs (e.g., cath lab, GI lab, dialysis area, etc.)
- Surgical suites

*Roger Leib, AIA, ACHA, and David Green*

#### **1.2-5.2.2.4** *Destination points for patient transfers and movement*

One of the most significant benefits of lifting equipment is its usefulness in transporting patients and residents from one location to another (i.e., from bed to toilet, bedside chair, or elsewhere). When determining the track system for ceiling lifts, it is important to know the location of possible transfer points, and, when portable lifts will be used, adequate space for their use must be provided at destination points.

Ceiling lifts with tracks that provide full in-room coverage can support rehabilitation, allowing patients to ambulate within their room using a ceiling lift and ambulation sling. Thus, before undertaking track design and layout, it is important to consult with staff to determine destination points for transfers as well as the potential for rehabilitation use. See the sidebar on patient movement destination points for background on patient transport. Further information on track design and layout is located in Appendix K.

#### **1.2-5.2.2.5** *Sizes and types of door openings through which patient handling and movement equipment and accompanying staff must pass*

Typical patient room and associated toilet room doors should accommodate the base widths of portable/floor-based lifts (such as standard sit-to-stand lift base widths and standard full body sling lift base widths) along with accompanying staff members.

Bariatric patient room and associated toilet room doors should accommodate the expanded width of bariatric portable/floor-based lifts, along with several staff members. The width of bariatric room doors should be sized to fit specific equipment used by the facility. Use of a double door design is recommended.<sup>16</sup>

Throughout the facility, all other doors through which patients pass should accommodate the expanded width of portable/floor-based lifts and other equipment such as standard and motorized beds/gurneys/stretchers. When a bariatric population will be served, doors of procedure rooms and other areas should accommodate the expanded width of bariatric beds/stretchers/etc.

**Note:** Prior to design layout, verify portable/floor-based equipment dimensions with the existing or projected lift manufacturer.

#### **1.2-5.2.2.6** *Types of floor finishes, surfaces, and transitions needed to facilitate safe and effective use of patient handling and movement equipment*

Thresholds should be flush with the adjacent floor surface(s) to facilitate safe movement of rolling equipment. Transitions between different adjacent floor surfaces should be designed to eliminate tripping, bumps, and strain on staff pushing or guiding manual or powered equipment. Care should be taken in choosing flooring materials for patient care settings where rolling equipment is frequently used. From a safe patient handling and movement perspective, the increased difficulty of rolling wheeled equipment over carpeting compared to the effort required over less resilient flooring materials is an important factor when specifying flooring materials.<sup>17</sup> To minimize the difficulty of handling rolled equipment when carpeting is chosen for acoustical or other reasons, careful consideration should be given to selection of the carpeting material as well as to construction and installation specifications for the carpeting and its backing. In addition, the material, diameter, tread width, and suspension and steering systems for the wheels of rolling equipment should be carefully considered.

#### **1.2-5.2.2.7** *Coordination of patient handling and movement equipment installations with building mechanical, electrical, and life safety systems*

At least one facility elevator should be able to accommodate attending staff and motorized patient beds 8 ft. in length and expanded capacity (bariatric) beds.

Bariatric patients are handled similarly to normal weight patients in a fire situation; they are moved from one fire/smoke compartment to another on the same floor.

#### **1.2-5.2.2.8** *Storage space requirements and locations available or to be provided*

## PHAMAs Affect the Environment of Care

Since programming, planning, and design are iterative processes through which considerations such as the care model, staffing, operations, equipment, space, architectural and interior design details, surfaces, and furnishings are assessed, correlated, and resolved, a PHAMA can have a truly significant impact on the environment of care. Specifically, PHAM needs must be assessed and assistive equipment requirements determined so this information can inform the functional program, and ensure that all equipment selections, storage, circulation, and staff access and maneuvering requirements are addressed during its creation.

In establishing the functional program, it is advisable to involve a multidisciplinary team so that patient and staff needs can be adequately anticipated and addressed. As well, incorporation of specific equipment makes and models should be considered at this early planning stage so that all physical space requirements and details can be accommodated during the design phase. The goal is to maintain the intended care model and aesthetic while incorporating the required PHAM equipment.

Preparing mock-ups of patient/resident rooms, bathrooms, other patient/resident areas, and patient care support areas during the concept phase (or even earlier, during the programming and planning phase)—and testing them with frontline staff using actual proposed equipment and accessories—can be an excellent way to increase the designers' understanding of the issues and to resolve all ramifications of a particular equipment response to PHAMA recommendations. Further, caregivers who have participated in preparing a PHAMA's statement of requirements and selecting a consensus response will experience a sense of ownership in the choice of equipment. Their familiarity with it will also help them train and encourage peers and associates to actually and properly use the equipment.

Staff acceptance and consequent use of PHAM equipment will allow them to provide superior care that increases patients' comfort, dignity, and sense of independence and control; fosters faster and better rehabilitation regimens; and enables patient mobilization as soon as possible, at the same time protecting both the patient and the caregiver from injury. Prior to the opening of a facility, it is recommended that staff members who helped prepare the PHAMA recommendations, the functional program, and the design documents participate in developing training materials and sessions for the rest of the staff.

Following is just a sampling of design features to highlight how functional programming in response to PHAMA recommendations may benefit a completed project:

- Accessible storage areas that discourage “parking” of devices and equipment in corridors, where they impede circulation and create potential safety issues
- Recessed ceiling lift supports to minimize exposed tracks in a “residentially” styled, long-term care resident room
- Casework that serves multiple functions (e.g., storage that accommodates both a lift and slings and linens), all as part of a decentralized nursing station

Many other aspects of patient care and building design may appropriately be improved when patient handling and movement issues are identified in a PHAMA, addressed in the functional program, and resolved during the planning, design, construction and commissioning process.

*Jane Rohde, AIA, FIIDA, ACHA, AAHID, LEED AP; and Martin H. Cohen, FAIA, FACHA*

A method for calculating storage space requirements for floor-based lifts is located in Appendix J. These calculations do not include aisle, access, and other storage space needs. Information regarding storage for lift accessories (e.g., slings, hanger bars), other PHAM equipment, and infrequently used equipment can be found in Appendix L.

**1.2-5.2.2.9** *Impact of the installation and use of patient handling and movement equipment on environmental characteristics of the environment of care*

PHAMA recommendations contribute to the development of criteria for the functional program, which in turn informs development of the space program. Together, the functional and space programs guide space planning and design, then construction, and ultimately the commissioning of a project. For more information, see Chapter 1.2, Planning, Design, Construction, and Commissioning, in the 2010 edition of the FGI *Guidelines for Design and Construction of Health Care Facilities*.

### **1.2-5.2.2.10** *Impact of the installation and use of patient handling and movement equipment on the aesthetics of the patient care space*

Design professionals, who may be only just beginning to understand the workings of clinical settings, often focus primarily on aesthetics. It is in part what designers are paid to do—certainly in long-term care facilities, where the aesthetics of the environment have an outsize effect on marketability. On the other hand, most manufacturers of PHAM equipment began by exclusively focusing on engineering and functionality, although many suppliers' products have evolved to an admirable level of design sophistication. Creating a successful health care environment depends on consideration of both the visual impact of the individual PHAM equipment

elements and the overall aesthetic context of the space in which they will be used.

### **1.2-5.2.2.11** *Infection control risk mitigation requirements*

From the beginning of the planning process, organizations should include the infection preventionist (IP) in the equipment selection process to ensure that chosen equipment designs promote ease in cleaning and infection control. Manufacturers' instructions provide guidance on appropriate cleaning techniques, but the infection preventionist should develop infection control procedures based on recognized government and health care organization standards. To ensure that infection control is appropriate and sufficient to protect patients and staff during the ceiling lift

## **Aesthetic Conflicts in the Design of Health Care Environments**

Aesthetic conflicts affecting successful design in a health care environment stem from a variety of causes. The primary causes of this conflict are discussed in this sidebar.

**Mixing traditional and contemporary/modern design elements.** Basically, there are two aesthetic/design camps in health care: “traditional” and “contemporary” or “modern.”

“Traditional” describes design modes and appearance before the advent of modern design in the early 20th century. More than just the evocation of a particular historic design style (e.g., French Provincial or Country), this approach is distinguished by the appearance of natural materials and greater or even overall surface detailing, textural differentiation, and random-element or non-geometric patterning. It evolved in periods when much hand labor went into products, and more labor was available to meet cleaning and maintenance requirements. Whether true or not, many administrators and developers believe that a traditional environment feels more “homey,” especially to an older audience. Thus, traditional design, for better or worse, remains the norm for most residentially focused health care environments.

“Contemporary/modern” describes design modes and appearances that reflect machine manufacture and industrial fabrication techniques. It is characterized by man-made materials, little to

no surface detailing, and minimal textural differentiation along surfaces. The mechanical workings of building elements may be shown expressionistically, but more commonly they are hidden beneath shrouds or other smooth skins or coverings. Products in this style are inherently easier to clean (depending on the cleaners used and the nature of the surface material).

There are no hard-and-fast rules as to what works and what does not in the aesthetics of health care design. Chiefly, however, most conflict results from the contrast between the highly differentiated surfaces of traditional design elements (e.g., patterned wall coverings) and the large, undifferentiated surfaces that characterize contemporary/modern objects, including the new PHAM products currently in use and the mountings that support them.

**Scale.** While patients and patient furnishings are getting larger and PHAM considerations dictate certain clearances, rooms do not always accommodate these larger elements, either visually or functionally.

**Overly clinical appearance.** The lack of visual (and functional) integration among products from a vast number of health care product manufacturers means that clinical areas in particular become filled with large amounts of technological

*sidebar continues on next page*



installation process, refer to information on infection control risk assessments in Appendix M.

## The Impact of Bariatric and Morbidly Obese Patient Care on Design

The effects on design of caring for morbidly obese and bariatric patients must not be overlooked. In general, the following accommodations should be made when designing new facilities and renovating existing facilities:

- Accommodations for special bariatric equipment with appropriate weight capacities
- Larger door openings
- Handrails and grab bars with expanded weight capacities
- Elevators able to hold larger bariatric beds

- Doorways that permit entry and exit of bariatric equipment (wheelchairs, lifts, etc.).
- Corridors wide enough to turn and manipulate bariatric beds

As well, patient or resident rooms and associated toilet rooms suitable for safe bariatric patient care should be provided. These should be large enough to accommodate several pieces of large equipment (e.g., commode, wheelchair, floor-based lift) and six or more health care workers at the same time. In addition, extra-capacity (bariatric) ceiling lifts should be mounted in bariatric patient rooms.<sup>18</sup> Review of the bariatric safety checklist (Appendix N) may prompt additional thoughts regarding precautions for the care of bariatric patients.

*sidebar continued from previous page*

bits and pieces. When affordable, efforts are frequently made to hide some technology elements behind special enclosures—especially headwall utilities. But for more acute-level facilities, the amount of equipment that accumulates in a patient environment is often beyond what can conveniently and functionally be hidden or shrouded.

**Visually incongruous elements:** PHAM equipment, particularly when it is ceiling-mounted, is often visually incongruous with its setting. One of the most common examples of this issue is traverse-style ceiling tracks. Although the upper track may be recessed, the lower track is suspended below it and tends to conflict with anything else suspended from the ceiling, including lighting fixtures and cubicle curtains—elements that might otherwise soften the institutional appearance of such planar ceilings. One manufacturer has recently introduced a headwall system that conceals a traverse track when it is not in use, but other examples of visual and functional incongruity (including gantry-style lifts, wall-mounted lifts, and many portable hoists) await similar attention or superior solutions from the industry.

What can be done to resolve these aesthetic and functional conflicts?

*Manufacturers* can add features to primary patient support furnishings to reduce the need for a

secondary level of equipment and add textural differentiation to surfaces. In an attempt to fit their products into the aesthetic context of the space where they are used, some manufacturers have begun to offer surface treatments that turn what might otherwise be incongruous architectural elements into decorative accents. Such treatments are particularly effective in surface- or wall-mounted or traverse-style ceiling tracks.

*Designers can:*

1. Stick to contemporary/modern idioms that more readily accept the aesthetics of most industrially produced equipment.
2. Recess ceiling-mounted elements where possible.
3. Treat equipment as design elements rather than as foreign invaders.
4. Carefully consider storage and access. The best designs can be destroyed by storage of unintended elements in unintended places because inadequate thought was given to their volumetric and storage requirements and the ease with which they can be accessed or brought into use. If storage areas are too far from the point of use, equipment probably will not be used as intended.
5. Share ideas about improving the aesthetics of PHAM equipment with manufacturers. Often, the best ideas come “from the field.” And give your business to companies that are responsive.

*Roger Leib, AIA, ACHA; and Gaius G. Nelson, AIA*

## The ICRA and the PHAMA

Infection control risk mitigation recommendations (ICRMRs) for renovation projects or new construction in existing buildings come into play during preparations for construction. These written plans “describe specific methods by which transmission of air- and waterborne biological contaminants will be avoided during construction and commissioning.” For effective infection control risk mitigation, team members conducting the PHAMA should consult with an infection preventionist (IP) about the facility’s general infection prevention and control guidelines.

Installation of lift equipment requires input from—and regular interaction with—the facility’s existing infection control risk assessment (ICRA) team to address protection of patients and workers. Subjects for discussion should include at least the following:

- Patient placement and relocation
- Standards for barriers and other protective measures required to protect adjacent areas and susceptible patients from airborne contaminants
- Temporary provisions or phasing for the process of constructing or modifying heating, ventilation, and air-conditioning; water supply; or other mechanical and cabling systems
- Protection of adjacent occupied patient areas from demolition
- Measures for educating health care facility staff, visitors, and construction personnel regarding maintenance of interim life safety measures and ICRMRs

Infection prevention measures are required even for projects that seem simple, such as using equipment generically called a “control cube” (a portable floor-to-ceiling enclosure sealed tightly

to the ceiling along with a portable negative air machine, or NAM) when tiles are removed to assess the area above a ceiling for visible dust/mold contamination. Such basic operations at least require relocation of the patient to another room, given the movement of equipment and risk of unexpected contamination.

Installation of patient handling equipment that requires alteration of the physical fabric of a building will require more complicated infection prevention measures. For example, when ceiling tracks are installed, the entire room will need to be sealed and maintained with airflow into the room (i.e., negative with respect to the corridor). The intent of such measures is to ensure that barriers isolate the room/area and prevent contamination of adjacent occupied areas during the installation/renovation.

ICRMRs also require provisions for monitoring the infection control activities identified by the ICRA process, including written procedures for emergency suspension of work and for protective measures. These procedures also must indicate the responsibilities and limitations of each party (owner, designer) for making sure the procedures are followed.

There is no one best way to conduct an ICRA, comply with ICRMRs, or document the recommendations of the PHAMA panel. The ICRA matrix located in Appendix M offers one approach and includes a documentation form (*IC construction permit*) to help determine the level of precautions required for a particular project, based on the degree of anticipated contamination.

*Judene Bartley, MS, MPH, CIC*

## Endnotes

- 1 Ergonomics Technical Advisory Group, *Patient Care Ergonomics Resource Guide: Safe Patient Handling and Movement*, A. Nelson, ed. (Tampa: Veterans Administration Patient Safety Center of Inquiry, 2005). Available at: [www.visn8.va.gov/PatientSafetyCenter/safePtHandling](http://www.visn8.va.gov/PatientSafetyCenter/safePtHandling).
- 2 A. Nelson, unpublished research data from pilot study (James A. Haley VA Medical Center, Tampa, FL, 1996).
- 3 A. L. Nelson and G. Fragala, “Equipment for Safe Patient Handling and Movement,” in *Back Injury Among Healthcare Workers*, eds. W. Charney & A. Hudson (Washington, D.C.: Lewis Publishers, 2004), 121–35.
- 4 B. Owen and A. Garg, “Assistive devices for use with patient handling tasks,” in *Advances in Industrial Ergonomics and Safety*, ed. B. Das (Philadelphia, PA: Taylor & Francis, 1990).
- 5 M. S. Rice, S. M. Woolley, and T. R. Waters, “Comparison of required operating forces between floor-based and overhead-mounted patient lifting devices,” *Ergonomics* 52, no. 1 (2009): 112–20.
- 6 W. S. Marras, G. G. Knapik, and S. Ferguson, “Lumbar spine forces during manoeuvring of ceiling-based and floor-based patient transfer devices,” *Ergonomics* 52, no. 3 (2009): 384–97.
- 7 Occupational Health and Safety Agency for Healthcare (OHSAH) in British Columbia, “Ceiling lifts as an intervention to reduce the risk of patient handling injuries: A literature review” (Vancouver, BC: OHSAH, 2006).
- 8 E. Carlson, B. Herman, and P. Brown, “Effectiveness of a Ceiling Mounted Patient Lift System,” *AOHP Journal* 25, no. 3 (2005): 24–26.
- 9 P. L. Santaguida et al., “Comparison of cumulative low back loads of caregivers when transferring patients using overhead and floor mechanical lifting devices,” *Clinical Biomechanics* 20 (2005): 906–16.
- 10 A. L. Nelson et al., “Development and Evaluation of a Multifaceted Ergonomics Program To Prevent Injuries Associated with Patient Handling Tasks,” *Journal of International Nursing Studies* 43 (2006): 717–33.

- 11 C. Engst et al., "Effectiveness of overhead lifting devices in reducing the risk of injury to care staff in extended care facilities," *Ergonomics* 48, no. 2 (2005): 187–99.
- 12 H. M. Tiesman et al., "Effectiveness of a ceiling-mounted patient lift system in reducing occupational injuries in long term care," *Journal of Healthcare Safety* 1, no. 1 (2003): 34–40.
- 13 C. Engst, R. Chhokar, A. Miller, and A. Yassi, "Preventing back injuries to healthcare workers in British Columbia, Canada and the ceiling lift experience," in *Back Injury among Healthcare Workers: Causes, Solutions, and Impacts*, eds. W. Charney & A. Hudson (Boca Raton, FL: Lewis Publishers, 2004), 253–63.
- 14 S. Hignett and J. Arch, "Ensuring bed space is right first time," *Health Estate Journal* (Feb. 2008): 29–31.
- 15 "Special Handling and Movement Challenges Related to Bariatrics," Chapter 12 in Ergonomics Technical Advisory Group, *Patient Care Ergonomics Resource Guide*.
- 16 M. Muir and S. Gerlach, "Reducing the risks in bariatric patient handling," *Canadian Nurse* 99, no. 8 (2003): 29–33.
- 17 Rice et al., "Comparison of required operating forces between floor-based and overhead-mounted patient lifting devices."
- 18 M. Muir and L. Haney, "Designing space for the bariatric resident," *Nursing Homes/Long Term Care Management* (Nov. 2004):25–28.

### Establishing the Business Case for a Patient Handling and Movement Program

*Principal author:*

PHILLIP THOMAS, AIA

*Contributing authors:*

JOHN CELONA, BS, JD, AND MARY W. MATZ, MSPH, CPE

**P**revious chapters have discussed the risks posed by manual patient handling (both to patients and to caregivers) and the elements of a patient handling and movement assessment (PHAMA). This chapter will discuss how to determine the financial resources needed to implement a patient handling and movement program (PHAMP). A health care organization can use this information to build a business case for implementing a PHAMP.

In an increasingly cost-constrained health care environment, it is important to show that investment in patient handling and movement (PHAM) equipment and training (whether in a new or existing facility) is cost-effective and a good use of scarce capital.

In addition, the case must be made that, among the many competing priorities for funds to improve patient care, a PHAMP merits funding. This chapter will present a methodology for making an “investment-grade” evaluation of the total costs and benefits of such a program.

The first part of the chapter discusses the various benefits of instituting a PHAMP along with financing mechanisms. The second part will cover (1) how to quantify the total costs and benefits for a particular facility and (2) the opportunity this analysis creates to formulate new patient handling and movement alternatives that can increase the value of a PHAMP.

#### **Savings in Patient Health and Quality of Life**

The recommendations of a PHAMA can provide the foundation for new care plans that include patient handling equipment and minimize immo-

bility-related and other adverse patient outcomes that result in costs for the organization.

Possible negative impacts of manual patient handling on patients are discussed in Chapter 1 and include falls, skin tears, joint dislocations, fractures, pain, and inadequate mobilization. Although studies of patient outcome measures are few, indications are that positive relationships exist between the institution of a PHAMP and improvements in the overall quality of patient care as well as in specific outcome measures such as skin tears, falls, and mobilization. For example, when mobilization is limited, prolonged bed stays may result in diminished health status and functioning of patients,<sup>1</sup> leading to extended and/or repeated stays in health care facilities—with associated costs.

Among the complications known to arise from immobility are pneumonia, deep vein thrombosis (blood clots), insulin resistance, bed sores, and increased dependency (see the sidebar “Some Complications of Patient Immobility” in Chapter 1 for a more complete list). ICU stays during which patients are not mobilized can have devastating long-term physical and emotional effects that last beyond the illnesses that necessitated hospitalization.<sup>2</sup>

The conditions described above may occur in any direct patient care environment. The implementation of a PHAMP, coupled with proper equipment and adequate training and support, will influence their occurrence, resulting in real cost savings to a health care organization.

## Caregiver Savings

Many researchers who have undertaken trials of multifaceted safe patient handling programs with PHAM equipment as the key risk reduction element have achieved great success in decreasing both staff injuries and lost work and modified duty days.<sup>3</sup> When data on job satisfaction were captured, results showed increases in feelings of professional status and decreases in task requirements, which resulted in improved job satisfaction. Such positive outcomes were thought to increase nursing retention and have a positive effect on nursing recruitment,<sup>4</sup> thus affecting the quality of patient care and an organization's bottom line.

Implementation of a PHAMP has also been shown to improve caregiver efficiency, substantially decrease workers' compensation costs, and give a return on investment<sup>5</sup> ranging from two to four years.<sup>6</sup> Reductions in indirect costs caused by increased staff morale, decreased need for retraining and overtime pay, plus improvements in the quality of care and decreased associated costs have been estimated as high as five times the direct costs, but more commonly are around two times.<sup>7</sup>

## Financing

Current basic approaches to financing PHAM systems are (1) grants, (2) loss prevention loans, and (3) capital investments.

### Grants and Similar Funding Sources

Private and government (local, state, and federal) grants, endowments, or private donations may be available to fund the purchase of PHAM equipment, especially in localities that have adopted "safe lifting" legislation. This source of funds would be the ideal solution for a health care organization with financial challenges. Each organization should research what might be available locally.

### Accrued Savings Based on

#### Use of PHAM Equipment

Hospitals and nursing facilities have "sold" PHAM systems to fiscal decision-makers by outlining cost savings associated with workers' compensa-

tion insurance and reductions in claims, claim payouts, and premiums for this insurance. Some specialized companies that sell PHAM equipment will "guarantee" a specified cost savings based on their analysis and formulas.

The loss prevention option is the most practical and most frequently employed solution based on savings from implementing a PHAMP. Estimates of potential savings form the basis for development of a PHAMP budget. Such a program to reduce the risk of injury to employees and patients through training and use of appropriate equipment should result in successful loss containment. The savings should offset the cost of purchasing the equipment and implementing the program. With this option, the equipment cost can be financed and repaid using savings realized from insurance and incident reduction. This cost payback will take place over a few years, but reductions in claims and settlement costs will constitute a perpetual savings to the organization.

Research shows that reducing employee patient handling injuries produces a minimum of 30 percent and as much as 40 percent savings in workers' compensation claims and associated payments.<sup>8</sup> These are considered direct costs. In addition, indirect costs will be reduced from two to as much as four times the cost savings from workers' compensation claim settlement payments. Indirect costs include items such as employee replacement, incident investigation time, supervisor time, staff training and staff morale, social cost of pain and suffering, possible resident injury, breakup of work teams, administrative time, and paid overtime. The combination of decreases in direct and indirect costs will generate significant savings.

Direct financial outlays will include the cost of purchasing equipment necessary to reduce risk of injury. When construction activities are planned, the 2010 Guidelines require that each health care organization conduct a PHAMA to determine the need for and type of equipment that is best suited for the building structure and its patients. (See Chapter 2 and appendices for a discussion of how to make reliable equipment recommendations.) After suitable types of PHAM equipment have been determined, they can be priced by selected equipment companies. This will give the organiza-

tion actual cost estimates to run the projected savings scenarios for presentation to leadership. The cost scenarios and guarantees to the organization are typically provided by the equipment company or an independent consultant specializing in conducting patient care ergonomic evaluations and PHAMP implementation. (See Part 2 of this chapter for a comprehensive method for determining organizational cost benefits.)

### Out-of-Pocket Capital Investment

One final option is for the health care organization to pay for the equipment and training out of pocket, as part of doing business. The equipment may be financed through an internal appropriation, with an equipment loan, and/or as part of a major renovation or new construction loan package. The workers' compensation solution described above may serve as a secondary reason for choosing this approach because the cost can be justified and offset by the insurance claims savings.

### Endnotes

- 1 Chris Allen, Paul Glasziou, and Chris Del Mar, "Bed rest: A potentially harmful treatment needing more careful evaluation," *The Lancet* 354 (October 9, 1999): 1229–33.
- 2 Gina Kolata, "A Tactic to Cut I.C.U. Trauma: Get Patients Up," *New York Times*, January 11, 2009.
- 3 A. L. Nelson, M. Matz, F. Chen, K. Siddharthan, J. Lloyd, and G. Fragala, "Development and evaluation of a multifaceted ergonomics program to prevent injuries associated with patient handling tasks," *Journal of International Nursing Studies* 43 (2006): 717–33; J. W. Collins, L. Wolf, J. Bell & B. Evanoff, "An evaluation of a 'best practices' musculoskeletal injury prevention program in nursing homes," *Injury Prevention* 10 (2004): 206–11; B. Evanoff, L. Wolf, E. Aton, J. Canos & J. Collins, "Reduction in injury rates in nursing personnel through introduction of mechanical lifts in the workplace," *American Journal of Industrial Medicine* 44 (2003): 451–57; A. Nelson & A. Baptiste, "Evidence-based practices for safe patient handling and movement," *Nursing World / Online Journal of Issues in Nursing* 9, no. 3 (2004): 4.
- 4 A. L. Nelson et al., "Development and evaluation of a multifaceted ergonomics program."
- 5 K. Siddharthan, A. Nelson, H. Tiesman, and F. Chen, "Cost effectiveness of a multi-faceted program for safe patient handling," *Advances in Patient Safety* 3 (2005): 347–58; A. B. de Castro, "Handle with care: The American Nurses Association's campaign to address work-related musculoskeletal disorders," *Online Journal of Issues in Nursing* 9, no. 3 (2004).
- 6 K. Siddharthan et al., "Cost effectiveness of a multi-faceted program for safe patient handling."
- 7 Ibid.
- 8 Arjo USA, Injury Prevention Program Data.

## Establishing the Business Case—Understanding and Increasing the Value of a PHAMP at Your Institution

*Principal author:*

JOHN N. CELONA, BS, JD<sup>1</sup>

In this section, we present a method for creating an “investment-grade” business case for the value of a patient handling and movement program (PHAMP) at your institution, including how this analysis can be used to create new options that increase the value of a PHAMP.

In an ideal world, other programs competing for funding would be subject to similar analysis for an “apples-to-apples” comparison, but one must begin somewhere. The methodology presented is certainly applicable to any investment decision, although the particulars will differ. The specifics presented here result from an evaluation of the PHAMP at the Stanford Hospital and Clinics performed jointly by Strategic Decisions Group and Stanford Hospital and Clinics Risk Consulting.

### **The Simple Answer and the Fly in the Ointment**

Economics would describe the value of a PHAMP as the incremental value resulting from having a program in place compared to not having one. At a gross level, the calculation is simple:

- Calculate the total relevant economic value *with* a PHAMP.
- Calculate the total relevant economic value *without* a PHAMP.
- Take the difference between the two. This is the value *of* the PHAMP.

As a shortcut, directly analyze the incremental value created by the PHAMP compared with not having a PHAMP and restrict analysis to differences in costs and benefits resulting from implementation of a PHAMP. This was done in the Stanford analysis. With a comprehensive

valuation of incremental costs and benefits in hand, it is possible to create any number of specific financial metrics to support an investment decision and business case.

The fly in the ointment is that the total future benefits of a PHAMP are uncertain, as are the total future costs. It can be difficult to make a high-quality decision regarding whether to

### **Note for Smaller Institutions**

Smaller institutions may not have staff with the experience in financial and risk analysis and creating business cases that is needed to follow the methodology outlined here. Ideally, the analyst should have had coursework in decision analysis, which is part of the analytical methods core course at most business and engineering schools and some medical schools.

If no staff members with the appropriate skill set are available to calculate the actual costs and benefits for their facility, the results cited here can be used as a directionally correct indicator of the benefits to be expected from a PHAMP. However, divergences from Stanford’s results would be expected and should be kept in mind when using these results as an example. For instance, the benefits from reduced employee turnover will likely be greater at other facilities because the turnover at Stanford is exceptionally low. In addition, facilities with significantly lower patient mobility scores than at Stanford have the potential for a much greater return from a PHAMP.

This analysis at Stanford took about five man-days of an experienced analyst’s time, plus the time of Stanford personnel. As for referring the task to a specialist for a consultation, the value created is well worth the effort.

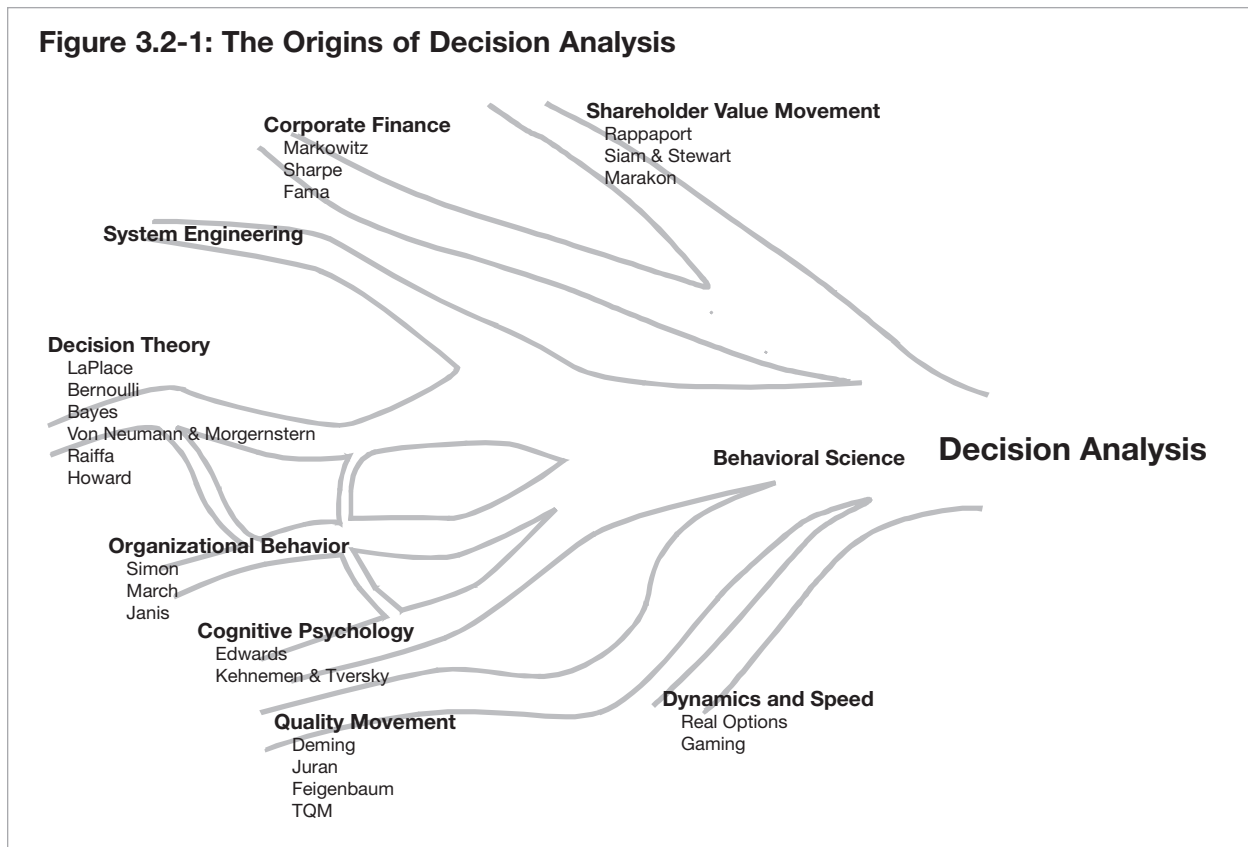

institute a PHAMP program in the face of uncertainty in both costs and benefits. However, the problem of making high-quality decisions amid uncertainty comes up fairly often in life. Each time we purchase (or choose not to purchase) insurance and decide on the amount of the deductible or select between a fixed or variable-rate mortgage, we are making a decision based on uncertainty.

When an organization considers whether and how much to invest in programs such as PHAMPs, a decision must be made today in view of future uncertain costs and benefits. Fortunately, the discipline of decision analysis was developed to address exactly this problem.

### **Decision Analysis Methodology**

You could ask: Why bother with the approach described here? Why not just prepare a projection with a single set of numbers, as is commonly done? Why create extra work?

The answer is that a single set of numbers cannot reflect reality. Ignoring uncertainty can only create a picture of what will not happen.

Strictly speaking, the probability of any single set of projections about a PHAMP (or any other program) coming to pass is zero.<sup>2</sup>

Understanding the possible variations in benefits and costs of establishing a PHAMP is critical to creating a robust and realistic business case. Could the costs be double? Or the benefits half? A variety of outcomes must be considered to create a defensible, robust, investment-grade business case and to present a picture that—with the uncertainty explicitly considered—is realistic.

The practice of decision analysis grew out of efforts to address the challenges of making high-quality decisions amid uncertainty. It stemmed from the confluence of a number of disciplines, as illustrated in Figure 3.2-1, drawing lessons from each.

Early work in Decision Theory contributed the use of probability to describe uncertainty and ways to structure decisions and uncertainties. The disciplines of System Engineering and Dynamics and Speed supplied the means for modeling and analyzing complex decisions and uncertainties and changing dynamics. Cognitive Psychology tackled the problem of how to think correctly

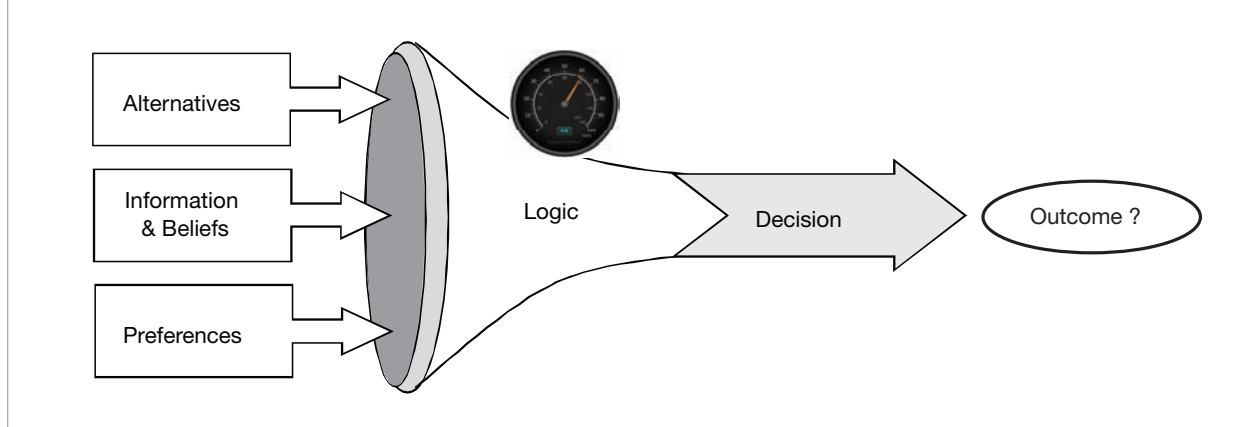

**Figure 3.2-2: The Elements of a Decision**

about uncertainty, while Organizational Behavior covered decision-making in organizations. Corporate Finance and the Shareholder Value Movement contributed financial metrics and valuation perspectives. The Quality Movement contributed notions for evaluating whether a decision is high quality. Seminal work in integrating all these threads was done by Howard Raiffa at Harvard University and Ronald Howard at Stanford University.

It is not within the scope of this chapter to provide complete instruction in the application of decision analysis (indeed, decision analysis is a four-year PhD program at Stanford). Rather, our purpose is to describe its application to creating an investment-grade business case for a PHAMP. More on the theory can be found in *Decision Analysis for the Professional*.<sup>3</sup>

Decision analysis has been extensively applied to medical decisions and in the public policy arena. Central to its approach are the steps of identifying, evaluating, and quantifying all the factors that bear on the costs and benefits of a particular decision. This understanding leads to creation of new alternatives for increasing the value to be gained from the decision that is made.

Done well, decision analysis produces a robust, transparent, and defensible understanding of total program value and a means of identifying how to increase program value. This understanding of the ways in which programs create value and the levers for increasing value can be communicated directly to decision-makers without the details of analysis.

Decision analysis has become the standard method of making investment and program decisions in a number of industries (including pharmaceuticals).

### The Decision Analysis Approach

Decision analysis applies a “divide and conquer” approach to developing a robust understanding of what the best course of action is and why.

#### **Decision Elements**

A decision is broken down into its component elements, as illustrated in Figure 3.2-2. These elements are explained below:

**Alternatives** are what you could do. In this context, they are having a patient handling and movement program or not having one as well as the different levels of investment possible if a PHAMP is adopted (e.g., a minimal installation versus a “gold standard” one).

**Information and beliefs** include all the information available on a topic, such as studies on the reduction in workers’ compensation claims from implementing a PHAMP. This category also includes judgments (expressed with probabilities) for uncertainties, such as estimates of future reduction in workers’ compensation costs at a particular facility. These judgments on the range of uncertainty for future costs and benefits are critical for building robustness and reality into the business case.

**Preferences** include a time preference for money (which determines the discount rate for calculating net present value of future cash

flows) and a risk preference. Unless the investment decision is so large that the ongoing viability of the facility is at stake (possible when deciding whether to acquire a hospital chain but not likely when deciding whether to implement a PHAMP), risk preference need not be quantified.<sup>4</sup>

**Logic** is captured in a simple spreadsheet model that shows the impact of making different decisions (e.g., different levels of investment in a PHAMP) and different outcomes for the uncertainties (costs and benefits). This usually requires simple formulas and range inputs for uncertain costs and benefits so it can calculate a result for any specified scenario.

The **Decision** is what you decide to do—for example, a minimal patient handling and movement program, an extensive program, or no program at all.

The **Outcome** is what happens once the decision has been acted on. Suppose you implement a PHAMP. How will the costs and benefits actually turn out? Only one set of numbers will describe what actually happens. If you've done a good job on the analysis, what happens will fall within the range of possible outcomes you projected. A comparison of the analysis and the outcome is where the quality of the analysis is born out.

Using ranges instead of single numbers to define uncertain costs and benefits is key to building reality and robustness into an analysis and a distinguishing feature of decision analysis. For every type of cost and benefit in a PHAMP, ask three simple questions:

- What is a number low enough that the chance of the actual outcome being lower is only 10 percent?

- What is a number high enough that there is only a 10 percent chance the actual outcome will be higher?
- For what number is there a 50/50 chance that the actual outcome will be higher or lower?

These questions are applied to every type of cost and benefit, including training costs, replacement and laundry costs for slings, reduction in workers' compensation claims, reduction in employee injuries, etc. (A more detailed list appears later in this chapter.) The rest of the spreadsheet is just simple formulas so that, for any setting of the inputs, you can calculate the total costs and benefits.

### Framework for a Good Decision

A framework based on the elements just described allows you to define a good decision for your facility—one that is logically consistent with the alternatives, information, and preferences you had at the time the decision was made. A good outcome is what you hope will happen.

This framework also ensures that you have a thorough and defensible understanding of the costs and benefits of the PHAMP proposed for your facility, a business case that will stand up to scrutiny, and a solid roadmap for what to expect with implementation.

Robustness is assured by using an iterative approach to building the business case. At each step, look at what you have and the results thus far and ask these questions: Does it all make sense? Are there alternatives we are overlooking? Is there better information we could get on, for example, the reduction in bedsores from implementing a PHAMP? This iterative approach is illustrated in Figure 3.2-3.

**Figure 3.2-3: The Decision Analysis Cycle**

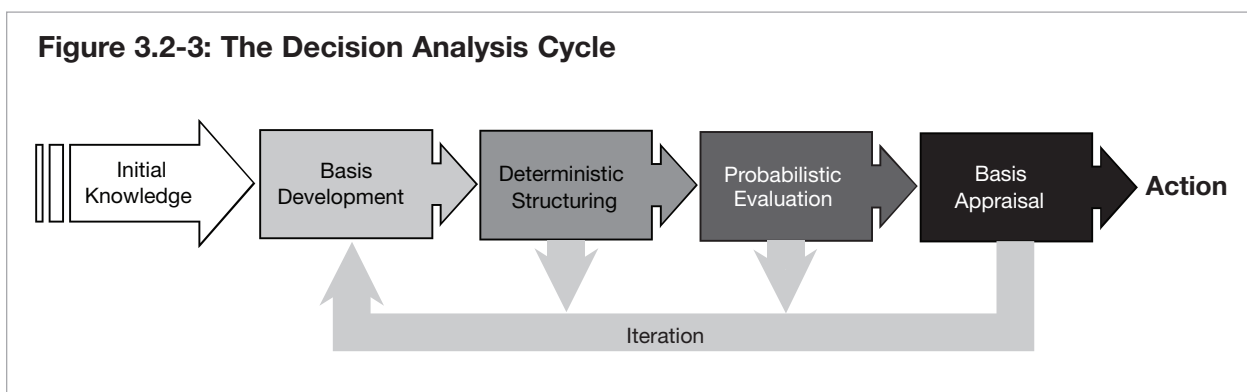

This iterative approach also provides a stopping point. When the critical drivers (discussed below) have been identified, estimates have been improved, and the recommendation still comes out the same, it is time to stop working the numbers. The inherent uncertainty in the costs and benefits is real, and you cannot make it go away with more analysis.

The objective is to achieve an understanding of the uncertainty that is sufficiently accurate in terms of the costs and benefits of each alternative to reveal both which is the best course of action and why this is so. This qualitative understanding is critical to the decision-makers. Your job is to get to that qualitative understanding with a reasonable balance between “extinction by instinct” and “paralysis by analysis.”

## Understanding the Value

The first step to understanding the total value of making a particular decision is to apply these structuring and analysis tools to the various PHAMPs you are considering, including no program at all. The second step is to use the results of this assessment to create new options that increase the value of the best alternative.

### **Basis Development and Deterministic Structuring**

Start with your initial knowledge, and think about the options available to your facility for addressing patient handling and movement issues.

The “no PHAMP” choice should always be considered. This sets the baseline against which comparisons can be made. If your facility is already in operation, seek available data on workers’ compensation claims from patient handling injuries, etc. For a new facility, averages from studies by others provide a starting point.<sup>5</sup>

Identify different alternatives for implementing a PHAMP at your facility. Other parts of this white paper provide guidance as to what may be required, and equipment vendors are always happy to provide a quote.

It is preferable to consider at least two levels of program implementation, perhaps a “bare bones” option and a “state-of-the-art” option. Another

approach is to consider how much equipment sharing between adjacent spaces may be feasible.

The purpose of studying multiple implementation options is to identify the trade-offs between incremental costs and incremental benefits. Suppose you do the “bare bones” implementation. Does that cost half as much as the “state-of-the-art” option, but provide only a quarter of the benefits? Alternatively, use of extensive portable lift equipment in an existing facility may achieve all the benefits of overhead tracks at half the cost. The choice that makes most sense will depend on your facility, including other renovation work any required changes to the physical environment could be coordinated with.

The point is that you need to consider multiple alternatives to find these sorts of relationships and arrive at the most cost-effective (highest value) alternative. If you don’t look for the trade-offs, you are unlikely to find them—and there’s a good chance these sorts of questions will be asked at the investment committee level.

The next step is to calculate the costs and benefits for each alternative. Making a list is a good place to start. Here are the potential benefits we identified at Stanford:

- Reduced patient falls and costs associated with them
- Reduced patient ulcers and treatment costs
- Increased patient satisfaction
- Increased referrals from satisfied patients
- Reduced staff injuries
- Reduced costs from workers’ compensation and lost or restricted work days
- Improved worker satisfaction
- Improved worker retention and reduced turnover costs

Some of these categories (such as reduction in lost or restricted work days) are ones your facility is likely to have studied. Some (such as improved worker retention from a PHAMP) have not been. This disparity is not an issue with this methodology. Just make the range wide enough to give you a high degree of confidence that reality will fall within it. In the case of Stanford, we estimated that, on the low side, a PHAMP would have no impact at all on turnover—because Stanford is a very desirable place to work and turnover is already so low. On the high side, we estimated that

turnover *among caregivers who handle patients* could drop by as much as 20 percent.

Such a calculation is straightforward: Project for perhaps five years the number of caregivers who handle patients. If you have very low turnover, use the historical turnover rate. If you have a high turnover rate, reduce that figure by 20 percent. Multiply the number of nurses who “didn’t leave” by the cost to train a new nurse (a well-studied number often put at \$60,000). The resulting figure is the value from reduced turnover contributed by a PHAMP.

The point is that, as you develop your list of benefits (and then costs), you need to think about how to calculate the financial impact of each, including how they may affect one another. The calculation method will consist of simple formulas and ranges for uncertain inputs, as illustrated with employee turnover.

For Stanford, we also developed a list of the costs:

- Initial capital costs for equipment, including labor for installation
- Ongoing costs for the equipment, including batteries, sling replacement, laundry cost for slings, etc.
- Costs for initial and ongoing training to instruct staff in how to use the equipment

The purpose of the cost and benefits lists is to make sure nothing has been forgotten. They are a starting point for figuring out how all the costs and benefits relate to one another to produce the total value for the program. If you’ve already started thinking about the relationships between the benefits and costs (as we illustrated for reduced employee turnover), you are part of the way there.

To capture all the factors and their relationships in a compact and intuitive form, use an influence diagram. Figure 3.2-4 shows the influence diagram developed for the PHAMP at Stanford. Interpreting it is straightforward:

- Decisions are indicated by boxes.
- The ultimate net value appears in a hexagon.
- Uncertainties appear in ovals.
- Arrows indicate the relationships between factors.

An influence diagram captures the decisions, costs, and benefits in one picture that shows how

they relate to one another—information that can be used to determine the value of the program. This diagram will also provide a map of what needs to go into the spreadsheet model. The box(es) describe alternatives that should be evaluated. Each oval is either a range assessment for an uncertainty or a formula in the spreadsheet. For example, the financial benefit of reduction in turnover is a function of reduction in turnover, the cost to recruit and train new staff, and the mix of staff (RN vs. support) who handle patients, as discussed previously.

This process of creating a valuation method is repeated for each part of the influence diagram. The goal is to translate each oval into uncertainty range assessments or formulas. At the conclusion of the process, simply add all the benefits and subtract all the costs.

Typically, numbers are projected for however many years make sense for the decisions being evaluated. For the PHAMP at Stanford, five years made sense because it was determined that was the period before the program would need a “refresh.” In contrast, when this methodology is applied to a longer-term facility decision (e.g., building a new mine), the life of the facility and the numbers of years projected will be greater (25 to 30 in the case of the mine).

Each year after a program has been implemented, calculate its cash impact should be evaluated. In the early years, the program will have expenses for equipment installation and staff training. In later years, cash spent on these will be freed up relative to how much costs would have been without the program.

A risk-free discount rate is used to discount the years of cash flow to a net present value. The discount rate should be the weighted average cost of capital for your organization (usually a weighted average cost of debt and equity capital, weighted according to the ratio of the two). Make sure your discount rate and projections are both given in the same terms—either real (inflation not included) or nominal (inflation included). Whether real or nominal projections are used typically does not affect the conclusions, so we usually make real projections.

By discounting the annual projections to a net present value (NPV), you can represent any

Figure 3.2-4: Influence Diagram for the PHAMP at Stanford

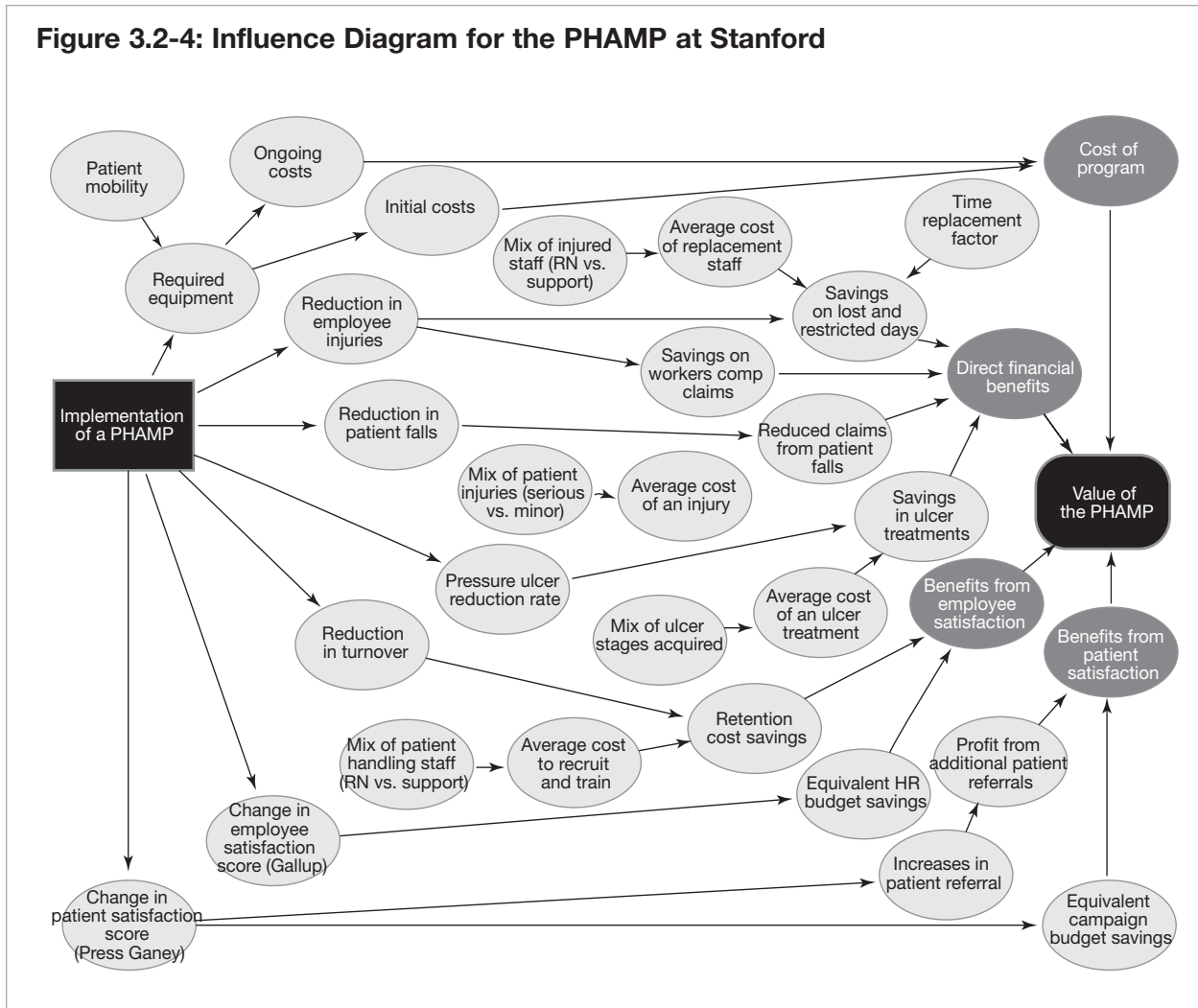

scenario with a single number—the NPV in that scenario—which is helpful for comparing many scenarios. Each uncertainty range (three numbers) leads to three scenarios. With eight different ranges, you have 38 or 6,561 scenarios. The combination of all those scenarios (all the uncertainties) creates a picture of program value you can have confidence in.

Before continuing, quality of life for patients perhaps bears special mention. In long-term care facilities especially, quality of life has become a focus at least as important as quality of care, if not more so.

For this analysis, we looked at specific measures indicating improved quality of life for patients and quantified how those measures contribute to the overall value of a PHAMP. For example, patients have better quality of life if there are reduced patient falls, injuries, and

pressure ulcers; therefore, we have quantified those directly.

Other results of improved quality of life are captured in assessments of increased patient satisfaction, which can produce a direct value (from increased patient referrals) and an equivalent value (e.g., how much would a public relations campaign cost to produce an equivalent increase in patient satisfaction?).

As with any value contribution we are interested in, the question of improved quality of life is how to model it to allow estimation of the value created.

Developing the lists, influence diagram, and range assessments and building the spreadsheet complete the Basis Development and Deterministic Structuring stages of the decision analysis cycle.

### Probabilistic Analysis and Review

Before beginning an explanation of this next step, let us recap why it is critical to use ranges to define uncertain factors. In addition to the two reasons previously discussed, we will add a third:

1. We can be highly confident that actual results will fall within the range assessed.
2. Using ranges enables quantification of factors that are difficult to quantify.
3. Ranges enable identification of which factors are the most important drivers for program value.

Identifying the most important value drivers is straightforward. When all the uncertain factors you assessed are set to the 50/50 (middle) value, we call the resulting program value the “base case value.” It is not what you expect to happen; rather, it is the result when everything is set to the 50/50 value. It is only a starting point.

We then go through and, one at a time, set each uncertainty to its low value, record the NPV, set it to its high value, record the NPV, and so on.<sup>6</sup> This process is also known as “deterministic sensitivity analysis.”

We then arrange the uncertain inputs from those causing the most change in NPV to those

causing the least, and plot the results on a graph. Because of the characteristic shape of this graph, it is called a “tornado chart.” The base case tornado chart for the PHAMP at Stanford is shown in Figure 3.2-5.

Producing this chart has three purposes:

1. **Identification of factors with the biggest value drivers for the program.** These are prime candidates for developing better estimates and creating new alternatives.
2. **Identification of factors that are not key value drivers.** It is not worth spending more time or money trying to develop better estimates for these factors (those small enough to fall below the top seven).
3. **Testing of your analysis.** The first key question for this chart is: Do you believe it? Does it all make sense to you, and can you explain how the variation in value produced by the top drivers occurred? If not, there is some sort of error or miscalculation in your analysis, and it should be corrected.

Before proceeding, you should be satisfied that all the variation shown in the base case tornado chart makes sense and reflects your best under-

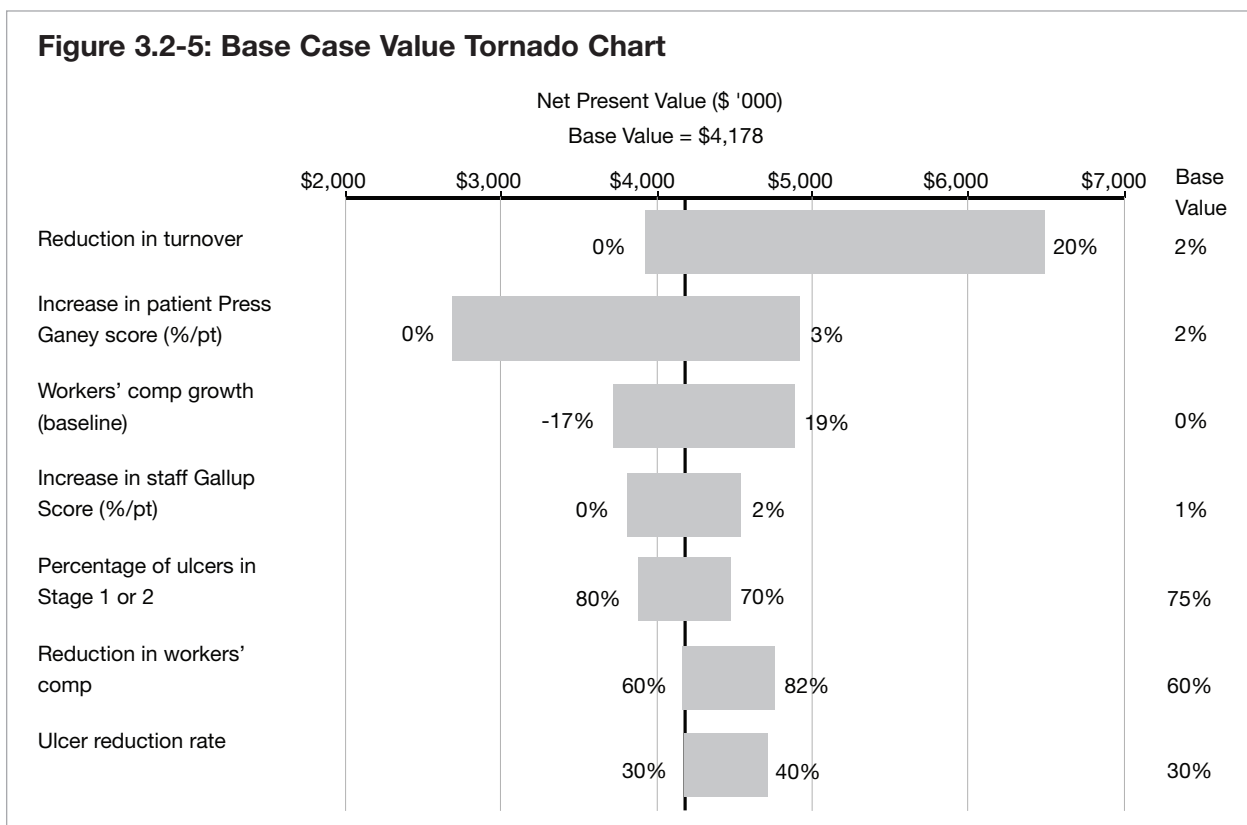

standing of the individual factors (uncertainty and calculation).

The next step is to look at what the total uncertainty is when all the uncertain inputs vary at the same time (which is what will actually happen). Software can considerably simplify this process, but many consultants insist on writing their own Excel macros.

Varying all the factors at the same time produces the probability distribution in overall program value.<sup>7</sup> Figure 3.2-6 shows the distribution for the value of the PHAMP at Stanford.

This chart is a cumulative probability distribution as opposed to the more familiar bell curve (probability density function).<sup>8</sup> We use this form because it makes it easier to see what is going on. For example, we can see that in a worst-case scenario (all costs at their highest and all benefits at their lowest), the PHAMP at Stanford will still add \$2 million in value over a five-year period. In a best-case scenario, the value added could be as high as \$10 or \$12 million. And, given all the uncertainty, the mean value<sup>9</sup> is that the PHAMP at Stanford will add \$5 million in value.

The PHAMP at Stanford looks like a winner.

However, these two charts (the base case tornado and the cumulative probability distribution) usually belong in the appendices of your package rather than up front. They are more for your purposes in debugging and making sense of

the analysis than for showing to executives. This is because the cumulative probability distribution is often difficult for people to interpret at first and because the base case is just the number with all the uncertainties set to the middle, which is often different than the mean value. (In the Stanford example, the base case value was around \$4 million, while the mean value is around \$5 million.) What we really want to show is the important messages of the tornado chart (the key value drivers and variability in value) based on the value considering all the uncertainty (the mean value) rather than the base case value.

Figure 3.2-7 shows the tornado chart based on the mean value (considering all the risks and uncertainties) rather than the base case value.

The calculation process for the mean value tornado chart is slightly different than for the base case value tornado chart. Instead of setting all the uncertainties to their 50/50 value (as for the base case chart), they are set to their mean value. The rest of the process is the same: Each uncertainty is set to its low and then its high value, and the resulting NPV is recorded and plotted from the biggest change in NPV to the smallest.

For presentation purposes, the mean value tornado chart is one of the two key charts we recommend showing. The second is the chart showing the breakdown between the investment cost and all the various categories of benefits that

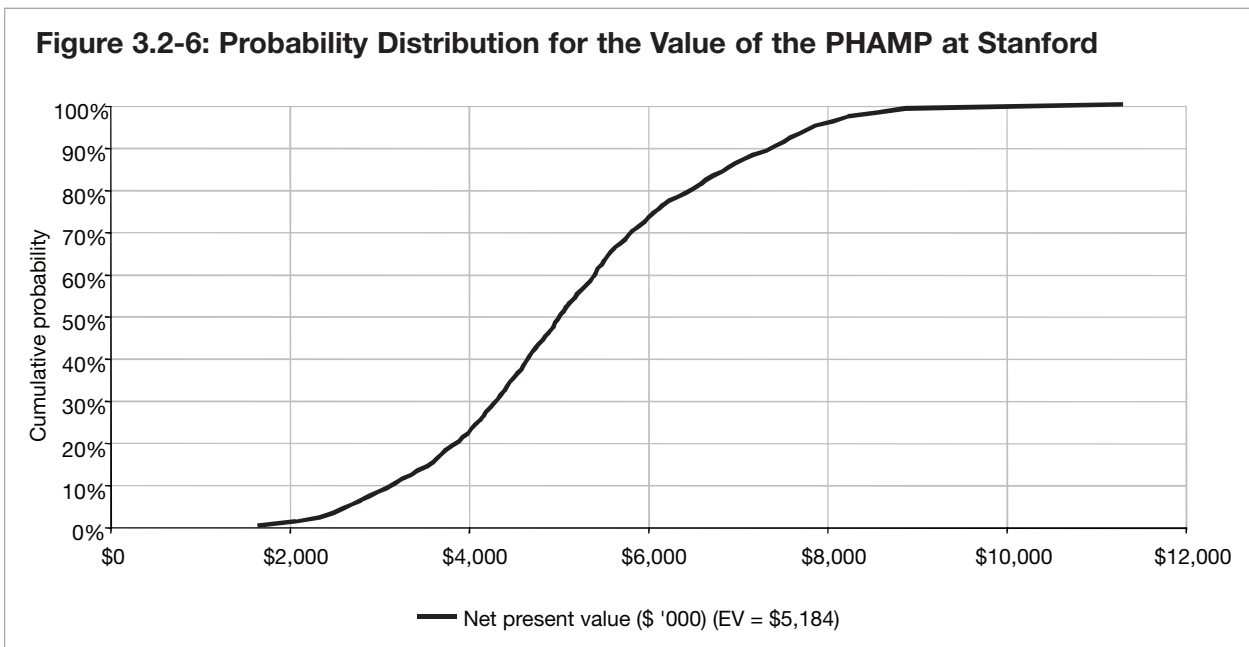

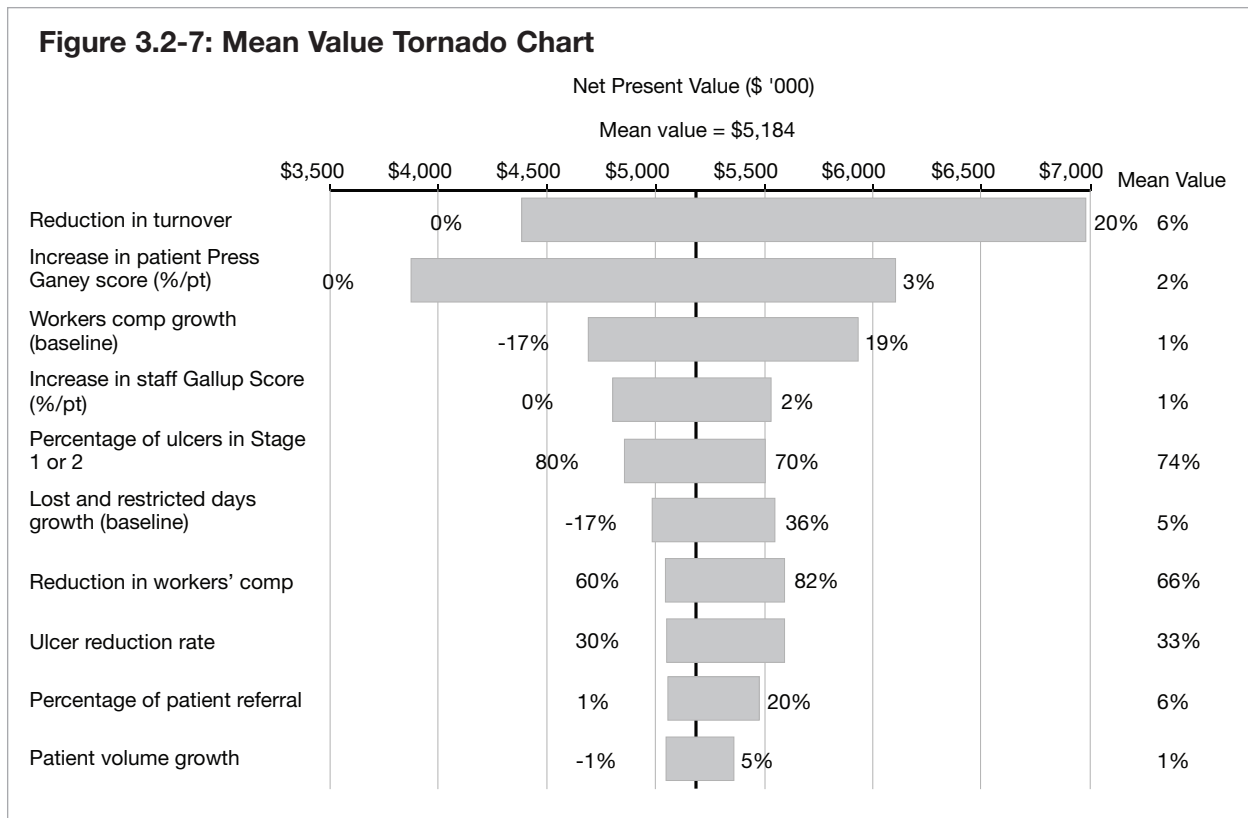

have been identified. This is usually displayed as a “waterfall” chart in which the various pieces add up to the overall mean value. The waterfall chart for the PHAMP at Stanford is shown in Figure 3.2-8.

This chart illustrates in one picture how the mean initial investment cost of \$1.5 million and the mean values of all the elements of value minus the \$144,000 in ongoing costs add up to the overall mean value of \$5 million contributed by the program.<sup>10</sup>

In the case of Stanford (as for many facilities), the PHAMP was initially justified based only on workers’ compensation savings and savings in lost and restricted days because these were the only two categories for which historical studies could be referenced. Also, equipment vendors sometimes guarantee savings in one or both of these areas.

The other areas of value are no less real; they are just harder to quantify. Focusing only on workers’ compensation and lost and restricted days missed 80 percent of the total value we expect the PHAMP to create at Stanford.

The order of categories in the waterfall chart is arbitrary and can be changed to suit different priorities for the decision-makers.

To accompany presentation of the mean value tornado and mean value waterfall charts to the investment decision-makers, other charts (e.g., the cumulative probability distribution and the influence diagram) can be included in appendices to address questions regarding how the study was conducted.

### Internal Rate of Return

Before moving on to the topic of value creation, it will be helpful to review the internal rate of return (IRR)<sup>11</sup> for the PHAMP at Stanford. Although investment committees often set a minimum “hurdle rate” for projects, we recommend looking at net present values for programs rather than internal rates of return for the following reasons:

- IRR identifies programs that have the highest rate of return rather than programs that create the greatest value. A very large project with a lower rate of return can create more total value than a small project with a high rate of return.
- If the cash flow does not change from negative in one year to positive the next year at least once, the IRR cannot be calculated at all.

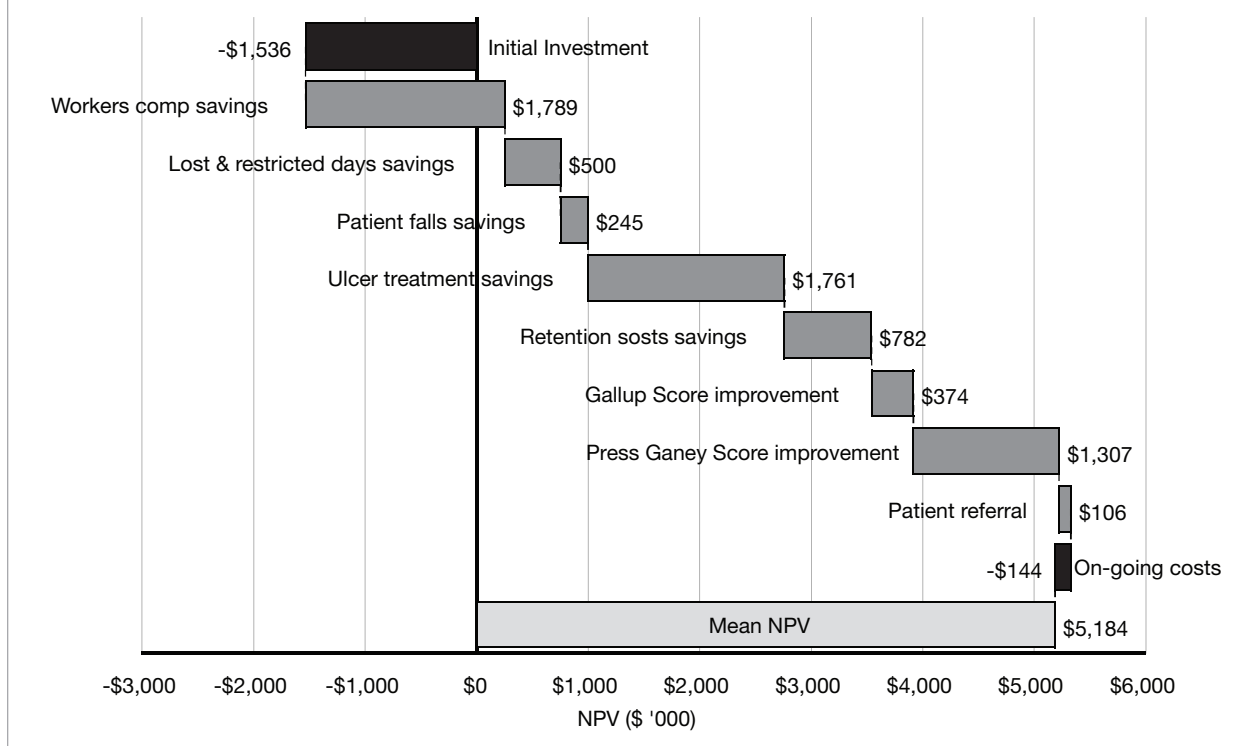

**Figure 3.2-8: Waterfall Chart for the PHAMP at Stanford**

- If the cash flow changes from negative to positive more than once (as when there is a “refresh” in patient handling and movement equipment), there will be multiple rates of return—all “correct.” This situation defies interpretation.
- IRR is not especially meaningful when projects have a very high IRR.

Still, in case the question does arise, you might place the probability distribution on IRR in the appendices. Figure 3.2-9 shows the cumulative probability distribution on IRR for the PHAMP at Stanford.<sup>12</sup>

We see that the mean value is an IRR of 111 percent, which is not especially meaningful. However, what may be of interest is that in the worst-case scenario (all costs at their highest and all benefits at their lowest), the IRR is still around 50 percent. In other words, there is virtual certainty that the IRR for the PHAMP at Stanford will exceed the organization’s IRR hurdle rate for investments.

You may recall from earlier discussion that we recommend analyzing at least two alternatives for implementing a PHAMP along with the “no program” option. For Stanford, we handled this by

analyzing the incremental value of implementing the PHAMP over not having a program. For reference, this makes the value of no PHAMP equal to zero. For all the charts, we could have included a zero value line to show the “no program” value, and you may elect to do so to ensure no misunderstanding.

We did not analyze multiple PHAMP options for Stanford because we conducted this study after the decision to implement a program had already been made and funded. Had we commenced earlier, we would have considered multiple options, as we recommend.

This concludes our discussion of how the methodology applies to understanding the total value of a program like a PHAMP—including the uncertainty of costs and benefits. An equally important topic is how this analysis leads to creating options to increase the value of a program.

### Increasing the Value

Stopping at understanding the uncertainty in costs and benefits for a proposed program leaves the job half done. One of the greatest strengths of

decision analysis is how it identifies the means for increasing a program's value. Two examples will be given to illustrate how this analysis can be used to increase the value of the PHAMP at Stanford.

Refer back to our mean value tornado chart (Figure 3.2-6). The uncertainty leading to the greatest change in the value of the PHAMP is the reduction in employee turnover. Depending on how successful the PHAMP is at reducing turnover, the program value could swing from around \$4 million to almost \$7 million, nearly double. The mean reduction in turnover is  $(.25 \times 0\%) + (.50 \times 2\%) + (.25 \times 20\%) = 6\%$ .

Suppose Stanford decided to invest \$100,000 in an employee communications plan to make sure caregivers use the PHAM equipment and understand its benefits. How much this program could help drive a larger reduction in turnover is uncertain; however, for illustration purposes, say the communications program could double the turnover reduction from a mean value of 6 percent to one of 12 percent—still much less than the maximum reduction of 20 percent. The graph shows that a 12 percent reduction would result in a program value somewhere around \$6 million (roughly halfway from the 6 percent mean value to the 20 percent maximum value).

In other words, if a communications program could double the turnover reduction from the mean value, that would create \$1 million in addi-

tional value—a 10-to-1 return on the \$100,000 cost. Stanford should consider funding an employee communications program as part of its PHAMP.

The second biggest swing factor in value is the improvement in patient survey scores from a PHAMP. Anecdotal evidence cited elsewhere in this white paper suggests that improved patient satisfaction is indeed a possibility. The mean value tornado chart suggests another million dollars in value could be created by supporting this outcome.<sup>13</sup> Likewise, Stanford should consider how to ensure that the patient benefits of a PHAMP are reflected in patient satisfaction scores. This may include, for example, feedback loops to ensure that patients are able to request use of PHAM equipment and that their improved satisfaction is captured in survey scores.

### A Compelling Case

Creating a compelling business case for implementing a PHAMP is crucial to ensuring adoption and to identifying the right level of implementation (e.g., the “Toyota” plan or the “Lexus” plan).

This chapter presented a methodology for quantifying the total costs and benefits for a PHAMP—including the uncertainty of those costs and benefits. Capturing that uncertainty is critical to ensuring development of a business case that is

**Figure 3.2-9: Cumulative Distribution for the PHAMP at Stanford**

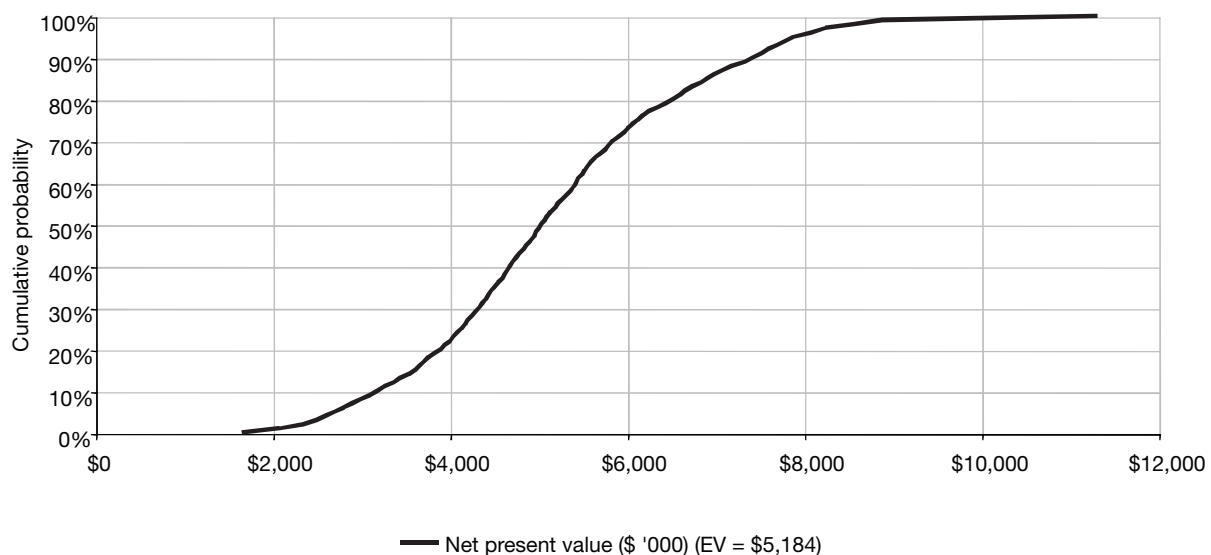

robust and defensible and accurately portrays the actual prospects for a program.

To summarize, this methodology has two phases:

1. Understanding the total value and uncertainty in costs and benefits for the options as formulated
2. Using the understanding of key value drivers to create new options for increasing the total program value

## Endnotes

- 1 The author would like to thank Jeffrey Driver and Ed Hall of Stanford University Medical Center Risk Consulting and Stephen Leung and Pratik Dalal of Strategic Decisions Group, who helped in conducting the analysis reported here.
- 2 When we are dealing with continuous variables (such as the reduction in workers' compensation claims from implementing a PHAMP), there are an infinite number of possible values: 30% reduction, 40% reduction, and all in infinite possible values in between. The probability of any single value occurring is  $1/\text{infinity} = \text{zero}$ . The problem is especially acute when dealing with many continuous variables, as in this case.
- 3 Peter McNamee and John Celona, *Decision Analysis for the Professional*, 4th ed. (Menlo Park, CA: SmartOrg, Inc., 2001–2007). Executive-level classes in Strategic Decisions and Risk Management (SDRM) are also offered by the Stanford University Center for Professional Development. (<http://strategicdecisions.stanford.edu/>)
- 4 Not quantifying a risk preference means that the alternatives will be evaluated on a risk-neutral basis; that is, the value to the decision-makers is exactly what dollar value is. For bet-the-company decisions, risk aversion typically comes into play where potential losses are weighted greater than the dollar amount. See *Decision Analysis for the Professional*, Chapter 5, for a complete discussion of attitudes toward risk.
- 5 K. Siddharthan, A. Nelson, H. Tiesman & F. Chen, "Cost effectiveness of a multi-faceted program for safe patient handling," *Advances in Patient Safety* 3 (2006): 347–58; M. O. Brophy, L. Achimore & J. Moore-Dawson, "Reducing incidence of low back injuries reduces cost," *American Industrial Hygiene Association Journal* 62 (2001): 508–11.
- 6 Sensitivity analysis software considerably simplifies this process. A number of packages are available to automate the process, including Supertree, available from SmartOrg, Inc.
- 7 To assess ranges, we asked for a number for which there's a 10% chance the actual will be lower, a number where there's a 10% chance the actual will be higher, and a number where there's a 50/50 chance the actual will be higher or lower. This allows us to guess at the rough shape of the distribution describing the uncertainty without having to establish a functional form (normal, lognormal, etc.) which we simply don't have the data to do. It also breaks this unknown distribution into three convenient pieces. For the lower end of the distribution where there's a 25% chance of being in that part of the distribution, the mean is the 10% low number. Likewise, for the upper part of the distribution (25% chance of being in that part), the upper 10% number is the mean. The 50/50 number is the mean of the middle part of the distribution (50% chance of being in that region). Accordingly, for varying all the uncertainties at the same time, we can say there's a 25% chance of the low number, a 50% chance of the 50/50 number, and a 25% chance of the high number. This allows us to calculate probabilities for individual scenarios and to assemble an overall probability distribution.
- 8 The cumulative probability curve is obtained by integrating the probability density function (summing up the pieces as you go along).
- 9 The mean value is the same as the expected value, abbreviated as EV in the chart.
- 10 For the purposes of this presentation, we used a national average for the incidence rate of bedsores rather than the actual rate at Stanford. Because staff there have been diligently addressing this issue, the bedsore rate and the value created in this area at Stanford would be expected to be less.
- 11 Mathematically, the internal rate of return is the discount rate at which the net present value of a series of cash flows is zero.
- 12 This chart is created by the same process of running scenarios for all combinations of the uncertainties, but recording the IRR in each scenario rather than the NPV.
- 13 You may have noticed from the cumulative probability distribution shown in Figure 3.2-6 that the PHAMP at Stanford has a potential of creating value in the \$10–12 million range. The question we are addressing is how to get there.

# CHAPTER 4

## Facilitating Acceptance of a PHAMP and PHAM Technology

*Principal author:*

MARY W. MATZ, MSPH, CPE

At one time, many health care leaders thought that simply introducing patient handling and movement (PHAM) equipment was sufficient to change the way caregivers perform their work, but over and over organizations have found this is not the case. Recognizable leadership support, program support structures, and the cooperation of a variety of hospital entities are required to change entrenched ways of performing tasks. Consequently, as important as it is to conduct a PHAMA and incorporate its recommendations into the design of a new building or renovation project, implementation of a patient handling and movement program (PHAMP)—also known as a safe patient handling and movement (SPHM) program—is necessary to ensure that PHAM equipment is actually used and the organization sees a cost benefit.

The Department of Veterans Affairs (VA) has been a leader in facilitating safe patient handling best practices, program acceptance, and implementation around the country.<sup>1, 2</sup> Elements of the OSHA guidelines were adopted from the VA program. The American Nurses Association (ANA) used the basic concepts from the VA SPHM program to develop its Handle with Care program.<sup>3</sup> Other health care organizations have taken the lessons of the VA and other PHAM programs and run with them, developing their own programs to promote a safe environment of care.

Not all health care organizations have opted to implement a PHAMP or to make use of PHAM equipment to protect their staff and patients, however. The decision to implement a program depends on an organization's basic organizational values and other factors that define its "culture of safety." (Factors that define a culture of safety are summarized in Table 4-1.<sup>4</sup>)

Movement toward creation of an effective culture of safety entails a fundamental change in organizational thinking. To bring about such significant change requires an understanding of all that goes into creating the best possible environment of care, including the physical setting and patient handling technology. To be sustainable, the change must be built on person-centered values and on a vision of the patient, who, after his or her encounter with the health care organization, is as mobile as possible, functions at as high a level as possible, and is as healthy as possible. The patient also should be maximally involved in the care process and as informed and prepared as possible—together with his or her personal supporters—to continue into the next venue of care. Means for achieving this vision include patient handling and movement assistive technology, staff members who are trained to properly use the technology, a complementary design for the physical setting, and a PHAMP with structures that support this vision.<sup>5</sup>

As is apparent by now, use of PHAM equipment is the overarching program element in a PHAMP and, because of this, much of the implementation process revolves around the time when equipment is introduced. But even though PHAM equipment is essential, knowledge transfer program support structures and change strategies must be in place right from the beginning for program success. After institution of the VA SPHM program, the clinical units involved were well on their way to providing an effective culture of safety. The elements of the successful SPHM program were comprehensive and included not only PHAM equipment and an ergonomic process to determine equipment needs but also appointment and training of facility SPHM coordinators/champions,<sup>6</sup> facility SPHM advisory

**Table 4-1: Factors that Define a Culture of Safety and Ranges of Attainment**

Aspects of a Culture of Safety	Range of Attainment	
	Negative (Traits showing lack of an effective culture of safety)	Positive (Traits showing an effective culture of safety)
<b>Values</b>	Focus is on productivity.	Focus is on maintaining a safe patient care environment for staff and patients.
<b>Available technology</b>	The facility/organization has no or little patient handling and movement (PHAM) equipment.	PHAM technology is state-of-the-art and found throughout the facility and/or there is progress toward that goal.
<b>Procurement of equipment</b>	The purchasing department directs selection and purchase of PHAM equipment/materials.	Frontline workers are actively involved in selecting PHAM equipment.
<b>Social interaction</b>	Management uses a top-down approach.	The workplace is one where employees are empowered and co-workers are guided by a collective belief in the importance of safety, with the shared understanding that every member will uphold the group's safety norms.
<b>Language</b> (Terms/phrases used as descriptors)	The terms "injury" or "accident" are used. Staff members call out for "Big Boy" beds.	The terms "minimizing risk" and "safety" are used. Staff members take into consideration the feelings of obese patients and use "expanded capacity" or some other "sensitive" term.
<b>Knowledge transfer</b> (Sharing of knowledge and information learned from doing a job and/or written information)	Staff members only follow procedures and policies.	Staff members are allowed to use the knowledge they have gained from doing their work and their creativity to improve their workplace.

teams,<sup>7</sup> and unit/area SPHM peer leaders.<sup>8,9</sup> Extensive training on equipment and program elements was conducted, in addition to other avenues for transferring information.<sup>10, 11, 12</sup> Written assessments utilizing ergonomic algorithms and guidelines provided an efficient knowledge transfer methodology plus the desired consistency in determining patient handling techniques and patient equipment needs.<sup>13, 14, 15, 16, 17</sup> Lifting teams were not included in the VA program, but there is ample evidence to support their inclusion in a PHAMP.<sup>18</sup> (Please note that although the program elements described here are listed sequentially, they often overlap and may be enacted in a different sequence.)

This chapter provides guidance for (1) readers who are learning about a PHAMP for the first time, (2) readers who already have an existing program in place and would benefit from a few program implementation or maintenance pointers, and (3) readers who would like to benchmark their program.

Often, one or several persons who have been educated about safe patient handling concepts or who have seen firsthand the impact of patient handling injuries are the initial drivers behind the decision to implement a PHAMP in an organization. Sometimes these staff members become facility coordinators/champions, but not always. PHAMPS also may be instituted as a result of a

PHAMA process. In any case, at least one person will head the charge for the long term. The information presented in this chapter is aimed at those directing the PHAMP.

## Getting Started

A number of steps involved in getting a PHAMP off the ground are outlined here.

### Promote the Safe Patient Handling Concept to Leadership

Frequently, the first task of an individual working to initiate a patient handling and movement program is to garner upper management/leadership support for the program. To do this, an organization's bottom line—financial well-being—must be addressed. The good news is that over the long term, financial benefits are seen when an organization implements a PHAMP, including acquisition of the necessary PHAM equipment.<sup>19, 20, 21, 22</sup> See Chapter 3 for strategies for developing a business case for instituting a PHAMP.

In addition to the cost benefit of implementing a PHAMP, education on the rationale for the PHAMP, including the benefits for patients, staff, and the organization, should be communicated to upper management. A quick overview of desired PHAM equipment is also helpful. This education effort should be ongoing, with leadership continually updated on the status of the PHAMP.

### Identify a SPHM Facility Champion/Coordinator

To maintain and even improve a PHAMP, a facility needs a strong and proactive facility coordinator as well as a peer leader program. Facility coordinators can creatively keep peer leaders involved, invested, and cohesive as a unit and are integral to implementing and sustaining a successful PHAMP.

At least one full-time facility coordinator is essential for program implementation success in large hospitals, nursing homes, and other facilities. For health care organizations with many facilities, it is helpful to have one person oversee all of the facility coordinators. Smaller institutions may be able to implement their program with a part-time staff member.

## PHAMP Benefits for Presentation to Leadership

Patient handling and movement programs have been known to fail from lack of support from organizational leadership and management. This lack of support commonly results from insufficient understanding of patient care ergonomics, inattention to safe patient handling and movement issues, lack of incentives, outdated policies, space constraints, and cost concerns. These roadblocks can be addressed by emphasizing the following benefits of instituting a PHAMP:

- Decreased costs related to patient handling injuries<sup>23, 24, 25, 26, 27</sup>
- Solidification of a designation as an “employer of choice”<sup>28, 29</sup>
- Improved recruitment<sup>30, 31</sup>
- Increase in staff satisfaction, improved perception of professional status and task requirements<sup>32, 33</sup>
- Improved staff retention<sup>34</sup>
- Decreased injuries from patient handling tasks<sup>35, 36, 37, 38, 39</sup>
- Enhanced regulatory compliance<sup>40</sup>
- Improved staff efficiency<sup>41</sup>
- Improved patient safety<sup>42, 43</sup>
- Facilitation of a culture of safety<sup>44</sup>

The person selected as facility coordinator should have a clinical background, preferably in either nursing or therapy, and be accustomed to handling, moving, and mobilizing patients. However, some facilities have appointed an individual from the safety staff with ergonomic knowledge. Most often, facility coordinators report to a nursing director. A resource guide for facility coordinators is available at [www.visn8.va.gov/patientsafetycenter/safePtHandling/default.asp](http://www.visn8.va.gov/patientsafetycenter/safePtHandling/default.asp). The facility coordinator's role is to implement the PHAMP throughout the facility and minimally includes the following:

- Conducting patient care ergonomic evaluations to develop recommendations for patient handling technology based on the needs of each clinical unit/area
- Facilitating PHAM equipment purchases
- Preparing for and coordinating equipment arrival, introduction, and installation
- Leading and acting as the resource person for the unit/area SPHM peer leaders

- Training/educating SPHM peer leaders, staff, management, and administrators
- Leading the facility SPHM team
- Acting as liaison between staff and management and administrators
- Acting as liaison between other organizational entities that affect the SPHM program
- Acting as the facility bariatric patient handling expert
- Tracking PHAM equipment and slings
- Tracking PHAM equipment use and maintenance
- Reviewing/identifying trends in patient handling injuries
- Reviewing/ identifying trends in patient outcomes related to patient handling activities
- Other duties related to the SPHM program

#### **Institute a Facility SPHM Advisory Team**

An interdisciplinary team should be appointed to serve as advisers to the PHAMP. The team members may include some or all of these: SPHM peer leader representative; SPHM facility coordinator; nurse/facility educators; direct patient care staff representatives (from nursing [LPN, CNA, RN], therapy [OT, PT], radiology, and other patient care areas); staff from employee health, safety, union, and contracting/purchasing departments; risk manager; engineers/designers; nursing administrator; and patient/resident. The team may be an informal group or a more formal entity chartered by the facility environment of care committee or facility management.

The purpose of the team is to provide support to the facility coordinator by assisting in the following duties. (If the team is formed prior to selection of a facility coordinator, team members also aid in the selection process.)

- Implement the PHAMP.
- Develop policy.
- Develop process.
- Facilitate program buy-in from other key players.
- Ensure incidents/injuries are investigated.
- Review patient handling injuries/trends.
- Facilitate equipment purchases (machines, accessories, slings).
- Develop long-term and short-term strategic plans.
- Drive the program using goals and objectives.

#### **Promote Critical Connections**

In health care organizations, a safe patient handling and movement program is often thought of as a “nursing” program, but staff quickly learn that a PHAMP affects a surprising number of departments and people. If these “stakeholders” are not included in program planning and implementation from the beginning, they can present significant barriers to moving the program forward. Institution of a PHAMP requires good working relationships with virtually all facility entities and services. Those with significant influence include, at a minimum, those listed here:

- Environment of care/facility safety committee/accident review board
- Safety/occupational health department
- Middle management/frontline supervisors
- Frontline staff
- Education staff (nursing and facility)
- Procurement/contracting staff
- Facility management/engineering/project management staff
- Housekeeping staff
- Laundry service
- Supply/processing/distribution staff
- Infection prevention staff
- Union

All of these entities can affect how easy it is to implement a PHAMP in a facility, so the sooner connections are made and the stronger the collaboration that results, the better. For some individuals who are promoting a SPHM initiative, though, forging relationships outside their normal work boundaries may be uncomfortable. Such individuals should partner with someone accustomed to working across the facility or read a book/attend a class on “asking the right questions,” “communication in business settings,” or something similar. See Appendix O: Making Critical Connections for SPHM Program Success, for elaboration on the importance of making critical associations with each entity listed above.

#### **Implementing and Maintaining a PHAMP**

Once a facility leader and team are up and running and working with various facility services and entities, the real process of program implementation begins. It is indeed a process and takes the

time and concerted efforts of many, not just those on the SPHM team. Successful completion of the process, and especially this phase, requires the support of organizational and middle management and the cooperation of many facility services, as previously noted. The larger and more complex an organization, the more time and care will be needed to successfully implement a PHAMP. There is no one single “right” way to implement a program; each one reflects the uniqueness of the organization. However, following the guidelines below will help ensure that no major parts of the program are missed in its planning and execution. Each organization chooses what is right for it.

### Develop Strategic Plans

Developing a strategic plan for the facility as a whole will give direction to the PHAMP and facilitate its success. Developing a plan for facility peer leaders as a group is also helpful, as is having peer

leaders from each unit/clinical area develop a plan unique to their area.

Strategic planning should be structured and include short-term and long-term goals and objectives. Include time limits for various phases, but be sure they are realistic; consult with others whose responsibilities might affect a time frame. Use marketing strategies to foster continued motivation of peer leaders, staff, management, and patients. Include strategies for continued training and succession planning for peer leaders. During this process, decide on what PHAMP elements to include in your program. Program element options are described in the section below titled “Select and Implement PHAMP Elements.” The organization’s culture and the needs of the facility, along with current PHAMP status, will help determine which elements should be included in your PHAM strategic plan. For additional information on patient handling and movement strategic plans, go to [www.visn8.va.gov/patientsafety-](http://www.visn8.va.gov/patientsafety-)

## Identifying Facility/Organizational Goals and Objectives

Goals should be individualized to meet the mission of your organization or clinical area/unit as well as your PHAMP. Some suggested goals follow:

- To reduce the *incidence* of musculoskeletal injuries
- To reduce the *severity* of musculoskeletal injuries
- To reduce *costs* from these injuries
- To create a *safer environment* and improve the *quality of life* for patients
- To improve the *quality of care* for patients, decreasing *patient adverse events* related to manual patient handling
- To encourage *reporting* of incidents/injuries
- To create a *culture of safety* and empower nurses to create safe working environments
- To increase the frequency with which caregivers are able to *move and mobilize* patients

Key objectives should be individualized to meet organizational or clinical area/unit needs and to consider information/data that is available or can be made available to measure outcomes such as effectiveness, acceptance, and support. Be sure to establish credible baseline statistics for objectives of interest prior to program implementation and to measure the same events periodically thereafter to gauge results. Use of the SMART

acronym is helpful: Each indicator should be (1) specific, (2) measurable, (3) action-oriented, (4) realistic, and (5) time-defined. Following are possible indicators:

- Reduction in manual transfers by \_\_\_% within \_\_\_ [chosen time frame (e.g., one year from program implementation)]
- Reduction in direct costs by \_\_\_% within \_\_\_ [chosen time frame]
- Decrease in nursing turnover by \_\_\_% within \_\_\_ [chosen time frame]
- Decrease in musculoskeletal discomfort in nursing staff by \_\_\_% within \_\_\_ [chosen time frame]
- Reduction in number of lost workdays due to resident handling tasks by \_\_\_% within \_\_\_ [chosen time frame]
- Reduction in number of light duty days due to resident handling tasks by \_\_\_% within \_\_\_ [chosen time frame]
- Improvement in patient outcomes such as decreasing skin tears or falls by \_\_\_% [chosen time frame]
- Decrease in patients’ average length of stay (LOS) by \_\_\_% within \_\_\_ [chosen time frame]

Source: A. L. Nelson, ed. *Patient Care Ergonomics Resource Guide: Safe Patient Handling and Movement*. Tampa: Veterans Administration Patient Safety Center of Inquiry (2001).



center/safePtHandling/default.asp. The following elements are often considered during strategic planning.

1. What goals related to safe patient handling do you want to achieve? (Individualize plans for yourself, your co-workers, your patients, and/or your unit/area.)
2. Identify target group(s) that will impact or be impacted by a PHAMP. Whom do you want to target and why?
3. Brainstorm to identify as many benefits of the PHAMP as possible.
4. Identify which benefits will be most convincing for each target group.
5. Identify potential staff-, patient-, and organization-level “barriers” to PHAMP implementation and maintenance and strategies to overcome these.
6. Identify staff-, patient-, and organization-level “facilitators” for PHAMP implementation and maintenance.
7. Identify the first five tasks you will undertake.
8. What strategies will you use to evaluate the success of each task?
9. What strategies will you use to maintain the interventions over time?

### Select and Implement PHAMP Elements

PHAMPs that are multi-faceted have been found to be the most effective. Although inclusion of PHAM equipment is key to a successful PHAMP, programs composed of only the equipment component have been largely unsuccessful. Other program elements with the most evidence demonstrating their value include patient care ergonomic assessments, safe patient handling and movement policies, and patient lift teams. The use of SPHM peer leaders and clinical tools such as algorithms for safe patient handling are more recent and less studied interventions that show great promise.<sup>45, 46</sup> See the sidebar for factors shown to be important in successful program implementation.<sup>47, 48, 49</sup>

PHAMP elements must function to transfer knowledge and facilitate change with the goal of encouraging acceptance of—and thus compliance with—new patient handling technology that reduces ergonomic risk and provides a safer environment of care for both patients and staff.

## Factors for Successful Program Implementation

According to a variety of sources, the following factors are important to success when implementing a patient handling and movement program (PHAMP):

- Redesign of equipment and the work environment
- Education/training in the use of PHAM equipment
- PHAMP peer leaders in each clinical unit/area
- Ergonomic evaluation/risk assessment of each clinical unit/area
- Patient assessment for each clinical unit/area
- Clearly communicated PHAM policy
- Change in work organization and practice

The VA conducted a research study that initiated what became a highly successful SPHM program by introducing the program elements below:

- Facility SPHM coordinator/champion
- Facility SPHM team/committee
- Unit SPHM peer leaders
- Safety huddle/after action reviews
- Patient care ergonomic evaluations
- PHAM equipment
- Staff training
- Patient assessment and algorithms for safe patient handling
- Safe patient handling policy

Phasing in the VA program elements in the order shown in the sidebar ensured that structures were in place to support knowledge transfer and staff members were familiar with change strategies. Appointing and training SPHM leaders and instituting safety huddles established a structure for participation in the patient care ergonomic evaluation process, which drove the recommendations and introduction of PHAM equipment. Since the use of the safe patient handling algorithms and adherence to a policy required the newly introduced PHAM equipment to be operational and staff training completed, these program elements were introduced last, after the equipment was in place.<sup>50</sup>

Detailed descriptions of the VA program elements discussed here (as well as lift teams, which the VA study did not include) are found in the book *Safe Patient Handling and Movement: A Guide for Nurses and Other Health Care Providers*.<sup>51</sup> For more information related to the VA program

elements listed in the sidebar, refer to Appendix P: Safe Patient Handling and Movement Program (SPHM) Element Descriptions. Further information can also be found on the VA Web site at [www.visn8.va.gov/patientsafetycenter/safePtHandling/default.asp](http://www.visn8.va.gov/patientsafetycenter/safePtHandling/default.asp).

### **Develop Standard Operating Procedures (SOPs)**

It is important to develop procedures specific to the types of PHAM equipment to be adopted prior to its introduction. In addition to following manufacturers' instructions and recommendations, each facility must develop its own guidelines and standard operating procedures (SOPs) for at least the following:

- Sling laundering, tracking, storage, distribution, and infection control
- Equipment cleaning and infection control
- Equipment maintenance and repair
- Equipment storage
- Others as needed

### **Facilitate Change and Program Acceptance**

Woodrow Wilson once said, "If you want to make enemies, try to change something." This is the challenge often faced when introducing equipment that changes the way caregivers do their work. However, sometimes knowledge of SPH concepts and the rationale for change can translate into power to advance rather than a roadblock to change.

Already discussed are program elements that facilitate change. For instance, peer leaders and lift teams act as change agents by promoting safe lifting practices and serving as resources for their co-workers. As SPHM change agents, peer leaders and facility champions assist in implementation of a program that promotes significant "thought" and "behavior" changes.

To be an effective change agent, a person needs knowledge of

- Why the program is being implemented (rationale/background)
- What the program includes (program elements)
- What will be used to implement the program (program materials/tools)
- How the program will be implemented (action plan)

Other strategies that foster change and knowledge transfer in a systematic way include those listed below. Brief explanations of a few of these follow the list. If you have further interest, many articles and books expand on these topics.

Change strategies include:

- Knowledge transfer mechanisms
- Education and training in SPHM
- Social marketing
- Coaching strategies and techniques
- Periodic review of PHAMP elements and status
- Development of strategic plans and action plans
- Leadership from unit/area peer leaders

**Knowledge transfer mechanisms.** In this context, the knowledge to be transferred is common information learned from doing work.<sup>52</sup> The information may be written in policies or procedures, but most important is what is found in people's heads—what they have learned from doing the work they do. Safety huddles, peer leaders, and lift teams act as powerful agents for knowledge transfer. They empower staff members by tapping into the knowledge they possess and facilitating exchanges of information. The ultimate purpose is to foster frontline staff acceptance of the PHAMP, and involving staff in program development and implementation nearly ensures this. Leaders who recognize that every person they lead has valuable information to share, and who listen to and act on that information, will effect change more easily and on a broader scale.

**Education and training in SPHM.** Education and training are forms of knowledge transfer and are critical for any organizational transformation. Staff, peer leaders, management, and leadership must be educated in the risks surrounding manual patient handling as well as in the technology to control those risks. In addition, peer leaders and staff must be trained on equipment use and SPHM program elements. Peer leaders will also need to learn techniques for facilitating staff behavior changes and adoption of the new program. Appendix Q: Safe Patient Handling and Movement Training Curricula Suggestions provides ideas for SPHM curricula for staff, peer leaders, and facility coordinators.

For continuity, plans must be made for ongoing SPHM orientation and training for new employees

and new peer leaders. In addition, to facilitate smooth transitions between outgoing and incoming peer leaders and to avoid a break in leadership, a strategy should be established for facility peer leader succession. This should include a plan for timely orientation and training of new peer leaders.

Education about SPHM concepts is also very important for patients and their families. The best place to start is when a patient is first admitted. Include a brochure in your organization’s admissions packet that summarizes your program, its rationale, and the PHAM equipment in your facility. Another effective way of increasing patient and family awareness of SPH concepts is to include a segment on the subject for the continuous loop video played on patient room televisions. A VA video includes clips of patients “flying, gliding, and sliding” easily from one place to another, making for a light-hearted and effective demonstration of the use of PHAM equipment.

SPHM curricula have been developed for schools of nursing; however, U.S. schools still teach outdated and risky manual techniques that have been banned in other countries (e.g., the United Kingdom, Canada, Australia, and the Netherlands). Progress is being made, though, and much of it is due to the efforts of the VA, ANA

### The Social Marketing Process

1. Define your goal(s).
  - What is/are your goal/s?
  - What do you want to change?
  - Why?
2. Identify target groups.
  - Whom do you want to target? (Staff, patients, nurse educators, facilities management, others)
3. Brainstorm to identify benefits of goal(s).
4. Match target groups with benefits.

(American Nurses Association), and NIOSH (National Institute for Occupational Safety and Health). These groups worked together to develop SPHM curricula for schools of nursing, which are available online at [www.cdc.gov/niosh/review/public/safe-patient/introduction.html](http://www.cdc.gov/niosh/review/public/safe-patient/introduction.html). Others, such as the American Physical Therapy Association (APTA), are also working to develop curricula. The APTA SPHM white paper can be found at [www.apta.org/AM/Template.cfm?Section=Archives3&TEMPLATE=/CM/HTMLDisplay.cfm&CONTENTID=18516](http://www.apta.org/AM/Template.cfm?Section=Archives3&TEMPLATE=/CM/HTMLDisplay.cfm&CONTENTID=18516).

**PHAMP marketing.** Discussed here are two approaches to marketing a PHAMP at your facility. One provides suggestions for determining marketing messages through the use of social

**Table 4-2: Sample Social Marketing Grid: Matching Benefits to Target Groups**

Target Groups	Benefits						
	Cost saving	Decrease injuries	Decrease injury severity	Decrease nursing turnover	Increase patient safety	Employer of choice	Others
Caregivers							
Nurse educators							
Nurse managers							
Nurse educators							
Facilities management							
Others							

### “Feed the Plants...Not the Weeds”

According to safe patient handling program implementation experts Hanneke Knibbe, Nico Knibbe, and Annemarie Klaassen of the Netherlands, a great coaching tip is to “feed the plants, not the weeds.” They say you can spend 80 percent of your time trying to change behavior in the 20 percent of people who are resistant, or you can spend 20 percent of your time fostering good behavior in the 80 percent who support your efforts. Which makes the best use of your time?

marketing techniques, while the other focuses on a variety of strategies for marketing the program to staff.

Social marketing offers a structured way to “sell” your idea or program. Engaging in the steps of the social marketing process (see sidebar) will allow you to strategically direct the focus of marketing efforts. For instance, although leadership would be very interested in the cost savings of implementing a PHAMP, nurse educators would likely be more interested in other benefits. Taking time to define your goals, identify groups important to the success of the PHAMP, and determine the benefits most relevant to each group will help you develop targeted “talking points” to increase the effectiveness of the marketing effort. Which benefit(s) will motivate each group? Using a grid to match benefits with target groups can be helpful, as shown in Table 4-2.

More general marketing techniques are also useful. You can never go wrong feeding caregivers to get their attention, and use of the traditional pens, mugs, T-shirts, and buttons is always good. Any type of program with recognition awards and rewards—such as a trip to a SPHM conference—certainly helps, but there are other creative ways to market your PHAMP. Refer to Appendix R: SPHM Program Marketing Activities/Strategies Aimed at Staff for some ideas.

**Using coaching strategies to support PHAMP implementation.** Coaching strategies are extremely important; it is actually much easier to learn the technical information related to a PHAMP (i.e., how to use a piece of equipment or how the body is affected by exceeding its biome-

chanical capabilities) than to promote personal behavioral changes and changes in the behaviors of others. Thus, training and practice on coaching techniques will help the SPHM change agents be successful.

Numerous books have been written on this subject, and many techniques are available. Table 4-3 summarizes the marked differences between the way the “worst” boss/supervisor and a “perfect” coach might behave. “Negative” boss behaviors do not engender staff input or program acceptance and should be avoided.

To understand the importance of coaching, you must understand the process by which coaching effects change. Change occurs on three sequential levels: (1) The intellect takes in information/knowledge and learns about the subject and the rationale for the change; (2) there is an emotional reaction, which combines with the information learned; and (3) change occurs. The second level can be experienced in a variety of ways. For instance, a person who has been injured during patient care or whose co-worker has had a debilitating injury may easily bind emotionally to the concept of safe patient handling and movement. Another person may internalize the information regarding the inherent risk in manual patient handling and the potential for serious injury. Still others may emotionally connect by way of negative organizational consequences for non-compliance.<sup>53</sup> What rewards or punishes one

**Table 4-3: “Worst” Boss vs. “Best” Coach Behaviors**

<b>BOSS</b>	<b>COACH</b>
Talks a lot	Listens a lot
Tells	Asks
Fixes	Prevents
Presumes	Explores
Seeks control	Seeks commitment
Orders	Challenges
Works on	Works with
Puts product first	Puts process first
Wants reasons	Seeks results
Assigns blame	Takes responsibility
Keeps distant	Makes contact

Source: M. Cook, *Effective Coaching* (New York: McGraw-Hill, 1999).

## Using Staff and Patient Injury Outcome Measures to Evaluate Program Effectiveness

Injury indicators of the effectiveness of a PHAMP must be used carefully. Many variables related to a patient's clinical and physical status may influence the effect of SPHM techniques and equipment. For instance, reductions in skin tears have been used as reliable indicators of the usefulness of ceiling lifts with repositioning slings or air-assisted lateral transfer devices. However, when using skin integrity as an indicator of improved quality of care, it is important to recognize that medical conditions and environmental and other factors can contribute to skin breakdown and consequential skin tears.

Staff injury data is always tracked as an indicator of effectiveness for PHAM equipment and program interventions. The severity of patient handling injuries should be captured as well. Severity indicators are total number of lost time days for all injuries, number of lost time injuries, total number of modified duty days for all injuries, and number of modified duty injuries. These statistics also must be used with care as a few

factors can make the data less helpful. First, under-reporting of patient handling injuries is surprisingly common, but, when staff are educated on safe patient handling risks and understand that their minor aches and pains may lead to more significant health problems, injury "reporting" may increase even when the actual incidence of injuries decreases. Second, patient handling injuries are usually the result of cumulative traumas and—as the name implies—are the result of the accumulation of "micro" injuries over time. An injury may have been initiated prior to the introduction of PHAM equipment but not reported at that point. If reporting occurs after PHAMP implementation, injury data will not show a true picture of program effectiveness. This cumulative characteristic of patient handling injuries also affects reports of lost time and modified duty days.<sup>55</sup> Finally, there is no universally accepted denominator for staff injuries, so it is difficult to calculate rates that allow for benchmarking and making comparisons between organizations.

person does not necessarily reward or punish another, though. Feeling good about the work they are doing is reward enough for some. The attitude of a supervisor toward an individual may be a reward or punishment, as might the attitude of a co-worker.<sup>54</sup> However it is attained, the combination of emotional attachment and knowledge fosters a change in behavior, the ultimate goal. It is the job of the coach to provide the knowledge and, when needed, to foster the emotional change in order to promote the behavior change.

### Evaluate the PHAMP

Program evaluation methods are a cornerstone of management oversight, and, for programs the magnitude of a PHAMP, evaluation tools should minimally relay the effectiveness, acceptance, and cost benefit of the instituted program.

Often, patient clinical outcomes/adverse events and staff injuries are the first PHAMP outcome measures that come to mind for demonstrating program effectiveness. However, a good understanding of the variables affecting these

measures is critical. Staff job satisfaction, patient satisfaction, peer leader activity (Appendix S: Safe Patient Handling Peer Leader Unit Activity and Program Status Log), staff musculoskeletal discomfort, use of PHAM equipment (Appendix T: Patient Care Equipment Use Survey), perception of the risk of patient handling tasks (Appendix H, Perception of High-Risk Task Survey Tool), cost comparisons, and other outcome measures also relay information about program effectiveness.

Information about designing a PHAMP evaluation and sample SPHM data collection tools for many outcome measures are found in the VA/DoD *Patient Care Ergonomics Resource Guide*, Chapter 11, at [www1.va.gov/visn8/patientSafetyCenter/resguide](http://www1.va.gov/visn8/patientSafetyCenter/resguide).

## Endnotes

- 1 A. L. Nelson et al., "Development and evaluation of a multifaceted ergonomics program to prevent injuries associated with patient handling tasks," *Journal of International Nursing Studies* 43: 717-33 (2006).
- 2 U.S. Veterans Health Administration, *Patient care ergonomics resource guide: Safe patient handling and movement* (Parts 1 and 2) (Tampa: Patient Safety Center of Inquiry, 2003). Accessed on 7/31/09 from [www.vishn8.med.va.gov/patientsafetycenter/safePtHandling/default.asp](http://www.vishn8.med.va.gov/patientsafetycenter/safePtHandling/default.asp).
- 3 A. B. de Castro, "Handle with care: The American Nurses Association's campaign to address work-related musculoskeletal disorders," *Online Journal of Issues in Nursing* 9, no. 3 (2004).
- 4 M. Matz, "Safe patient handling & movement/back injury resource nurse training program" (HealthCare Ergonomics Conference, Portland, Oregon, June 26, 2006).
- 5 Personal communication, David Green and Roger Leib, AIA, ACHA.
- 6 J. J. Knibbe, N. Knibbe, and A. M. Klaassen, "Safe patient handling program in critical care using peer leaders: lessons learned in the Netherlands," *Critical Care Nursing Clinics of North America* 19, no. 2 (2007): 205-11.
- 7 U.S. Veterans Health Administration., *Patient care ergonomics resource guide*.
- 8 Nelson et al., "Development and evaluation of a multifaceted ergonomics program."
- 9 A. L. Nelson, ed., *Safe Patient Handling and Movement: A Guide for Nurses and Other Health Care Providers* (New York: Springer Publishing Company, 2006).
- 10 S. Hignett et al., "Evidence-based patient handling: systematic review," *Nursing Standard* 17, no. 33 (2003): 33-36.
- 11 A. L. Nelson et al., "Development and Evaluation of a Multifaceted Ergonomics Program to Prevent Injuries Associated with Patient Handling Tasks," *Journal of International Nursing Studies*, 43:717-33 (2006).
- 12 Nelson, *Safe Patient Handling and Movement*.
- 13 A. Nelson et al., "Algorithms for safe patient handling and movement," *American Journal of Nursing* 103, no 3:32-34 (2003).
- 14 Hignett et al., "Evidence-based patient handling."
- 15 de Castro, "Handle with care."
- 16 Nelson et al., "Development and Evaluation of a Multifaceted Ergonomics Program."
- 17 U.S. Department of Labor, Occupational Safety and Health Administration. 2003. Ergonomics Guidelines for Nursing Homes. Retrieved on 9/30/09 from [http://www.osha.gov/ergonomics/guidelines/nursinghome/final\\_nh\\_guidelines.html](http://www.osha.gov/ergonomics/guidelines/nursinghome/final_nh_guidelines.html).
- 18 A. Hudson, "Back injury prevention in health care," in *Handbook of Modern Hospital Safety*, 2nd ed., ed. W. Charney, (New York: CRC Press, Taylor & Francis Group, 2010).
- 19 B. Evanoff, L. Wolf, E. Aton, J. Canos & J. Collins, "Reduction in injury rates in nursing personnel through introduction of mechanical lifts in the workplace," *American Journal of Industrial Medicine* 44 (2003): 451-57.
- 20 J. W. Collins, L. Wolf, J. Bell & B. Evanoff, "An evaluation of a 'best practices' musculoskeletal injury prevention program in nursing homes," *Injury Prevention* 10 (2004): 206-11.
- 21 A. L. Nelson et al., "Development and Evaluation of a Multifaceted Ergonomics Program."
- 22 U.S. Department of Labor, Occupational Safety and Health Administration. 2003. Ergonomics Guidelines for Nursing Homes. Retrieved on 9/30/09 from [http://www.osha.gov/ergonomics/guidelines/nursinghome/final\\_nh\\_guidelines.html](http://www.osha.gov/ergonomics/guidelines/nursinghome/final_nh_guidelines.html).
- 23 K. Siddharthan, A. Nelson, H. Tiesman & F. Chen, "Cost effectiveness of a multi-faceted program for safe patient handling," *Advances in Patient Safety* 3 (2005): 347-58.
- 24 Evanoff et al., "Reduction in injury rates in nursing personnel."
- 25 Collins et al., "An evaluation of a 'best practices' musculoskeletal injury prevention program in nursing homes."
- 26 Nelson, AL, Matz, M, Chen, F., Siddharthan, K., Lloyd, J., Fragala, G. (2006). Development and Evaluation of a Multifaceted Ergonomics Program To Prevent Injuries Associated with Patient Handling Tasks. *Journal of International Nursing Studies*, 43, 717-733.
- 27 de Castro, A.B. 2004. Handle with Care: The American Nurses Association's campaign to address work-related musculoskeletal disorders. *Online Journal of Issues in Nursing* 9(3).
- 28 Nelson et al., "Development and Evaluation of a Multifaceted Ergonomics Program."
- 29 M. Matz, "Analysis of VA patient handling and movement injuries and preventive programs" (internal VHA report to Director, VHA, Occupational Health Program, 2007). Retrieved on 7/30/09 from [www.vishn8.med.va.gov/PatientSafetyCenter/safePtHandling](http://www.vishn8.med.va.gov/PatientSafetyCenter/safePtHandling).
- 30 Nelson et al., "Development and Evaluation of a Multifaceted Ergonomics Program."
- 31 Matz, "Analysis of VA Patient Handling and Movement Injuries and Preventive Programs."
- 32 Nelson et al., "Development and Evaluation of a Multifaceted Ergonomics Program."
- 33 Matz, "Analysis of VA Patient Handling and Movement Injuries and Preventive Programs."
- 34 Nelson et al., "Development and Evaluation of a Multifaceted Ergonomics Program."
- 35 Ibid.
- 36 Matz, "Analysis of VA Patient Handling and Movement Injuries and Preventive Programs."
- 37 Evanoff, B., Wolf, L., Aton, E., Canos, J., & Collins, J. (2003). Reduction in injury rates in nursing personnel through introduction of mechanical lifts in the workplace. *American Journal of Industrial Medicine*, 44, 451-457.
- 38 Collins, J. W., Wolf, L., Bell, J. & Evanoff, B. (2004). An evaluation of a "best practices" musculoskeletal injury prevention program in nursing homes. *Injury Prevention*, 10, 206-211.
- 39 U.S. Department of Labor, Occupational Safety and Health Administration. 2003. Ergonomics Guidelines for Nursing Homes. Retrieved on 9/30/09 from [http://www.osha.gov/ergonomics/guidelines/nursinghome/final\\_nh\\_guidelines.html](http://www.osha.gov/ergonomics/guidelines/nursinghome/final_nh_guidelines.html).
- 40 Nelson et al., "Development and Evaluation of a Multifaceted Ergonomics Program."
- 41 Matz, "Analysis of VA Patient Handling and Movement Injuries and Preventive Programs."
- 42 Ibid.
- 43 de Castro, A.B. 2004. Handle with Care: The American Nurses Association's campaign to address work-related musculoskeletal disorders. *Online Journal of Issues in Nursing* 9(3).
- 44 Nelson et al., "Development and Evaluation of a Multifaceted Ergonomics Program."
- 45 A. Nelson & A. Baptiste, "Evidence-based practices for safe patient handling and movement," *Nursing World / Online Journal of Issues in Nursing* 9, no. 3 (2004): 4.
- 46 A. L. Nelson, A.S., Baptiste, M. Matz & G. Fragala, "Evidence-based interventions for patient care ergonomics," in *Handbook of human factors and ergonomics in health care and patient safety*, ed. P. Carayon (Mahwah, New Jersey: Lawrence Erlbaum Associates, Publishers, 2007), 323-45.
- 47 Hignett, S., Crumpton, E., Ruzsala, S., Alexander, P., Fray, M., & Fletcher, B. (2003). Evidence-based patient handling: systematic review. *Nursing Standard*, 17(33), 33-36.
- 48 U.S. Department of Labor, Occupational Safety and Health Administration. 2003. Ergonomics Guidelines for Nursing Homes. Retrieved on 9/30/09 from [http://www.osha.gov/ergonomics/guidelines/nursinghome/final\\_nh\\_guidelines.html](http://www.osha.gov/ergonomics/guidelines/nursinghome/final_nh_guidelines.html).
- 49 Nelson et al., "Development and Evaluation of a Multifaceted Ergonomics Program."
- 50 Ibid.
- 51 Nelson, A.L. (Ed) (2006). *Safe Patient Handling and Movement: A Guide for Nurses and Other Health Care Providers*. New York: Springer Publishing Company.
- 52 N. M. Dixon, *How Companies Thrive By Sharing What They Know* (Cambridge: Harvard Business School Press, 2000).
- 53 Matz, M. and Haney, L. *Unit-based Peer Leader Training Program*. 8th Annual Safe Patient Handling and Movement Conference. Lake Buena Vista, Florida, April 1, 2009.
- 54 F. Fourmies, *Coaching for Improved Work Performance* (New York, NY: McGraw-Hill, 2000).
- 55 Nelson et al., "Development and Evaluation of a Multifaceted Ergonomics Program."

# CHAPTER 5

## A Vision of the Future of PHAMPs

*Principal authors:*

ROGER LEIB, AIA, ACHA; DAVID GREEN; AND GAIUS G. NELSON, RA

The technology currently applied to patient handling and movement in various settings is, in some respects, in its infancy. Initially, patient handling and movement (PHAM) equipment was developed to assist caregivers with routine acts of daily care that require lifting and transporting patients. A rather large array of equipment has been produced for this purpose, particularly in the last decade. More recently, health care providers and researchers have recognized the importance of mobilizing patients as a means of maintaining or improving their health and optimizing short- and long-term outcomes by keeping them physically active as early and as often as possible.

Unfortunately, equipment that addresses the need for mobility is not widely available or affordable. In addition, the equipment that is available to support mobility is often not designed appropriately. In this chapter, we offer our vision for equipment based on two broad values: well-being of the patient as a whole person and staff safety and health. Two essential components of patient well-being are provision of the maximum opportunity for self-determination and maintenance of the patient's personal dignity. For staff to live out these values on a daily basis in all patient/staff interactions requires staff training as well as proper technology.

### **Perspectives for Achieving Optimal Patient Handling and Movement**

To make progress toward realizing our vision, health care organizations must keep the following concerns in mind when making decisions related to patient handling, movement, and mobility.

#### **Patient-Centered Focus**

Understanding the patient perspective must be the starting point for designing PHAM equipment.

Patient needs include not only their physical requirements but also their emotional, intellectual, and social needs.

- Physical needs include the use of all possible muscles and weight-bearing activities to maintain health and functioning and preclude the onset of immobility-related adverse events (see Table 5-1).
- Emotional needs include preservation of dignity during mechanically assisted movement.
- Intellectual needs include the ability to make as many decisions as possible related to assisted movement.
- Social needs include maintaining sitting and standing positions normally associated with social and clinical interactions.

All of these needs are most effectively addressed through active engagement of the patient in control of the PHAM equipment.

#### **Caregiver Focus**

Facilitating the ability of direct caregivers to respond to all of a patient's range of needs is essential for the well-being of patients and the safety and health of the staff. Equipment should be designed to enable all tasks that involve musculoskeletal stress, and the proper equipment should be located so it is convenient to use. Caregivers also need to be encouraged to problem-solve so they can respond to PHAM issues they have not previously encountered.

#### **Systems Thinking**

Many shortcomings in available PHAM solutions arise from failure to consider the health care delivery system as a whole and the interrelationship of all its elements. PHAM issues must be addressed contextually rather than as

**Table 5-1: Potential Effects on Patient from Loss of Mobility\***

<b>Physiological</b>	Bedsore Blood clots (deep-vein thromboses) Compromised breathing Compromised peristalsis, gas build-up, and constipation De-conditioning of gross muscles De-conditioning of cardiovascular system and reduced cardiac output Decreased bone density Insulin resistance Orthostatic hypotension and increased falls
<b>Behavioral</b>	Decreased field of vision Depression and anxiety “I’m sick” syndrome Increased dependency
<b>Institutional</b>	Increased burdens on staff Increased cost of care

\*Includes loss of ability to use all possible muscles and engage in weight-bearing activities.

isolated problems. The best solutions will consider these factors:

- Ease and efficiency of use of PHAM equipment
- Convenience of equipment storage locations
- Convenience of equipment charging/recharging
- Location of equipment relative to point of use
- Patient dignity
- Patient and staff safety
- Staffing levels
- Staff training
- Aesthetics
- Compatibility with other patient care equipment and functions
- Effect on building structure
- Impact on building systems (e.g., mechanical systems)

### Rethinking Basic Elements

PHAM equipment supplements basic care elements such as beds, chairs, and toilets. The design of these basic elements also must be rethought to determine what can be done to minimize the need for additional PHAM equipment and to facilitate interaction of these elements with equipment required for the patient activities of sleeping, sitting, toileting, and moving about.

### Ideas for Improvement

Ideas for improving PHAM equipment are many. The suggestions outlined here are divided into potential short-term improvements and those that will take more time to achieve.

#### Short-Term Solutions

These are suggestions for improvement of existing equipment and near-term development of new equipment:

- Beds that reduce or eliminate the need for the caregiver to lean over the patient (“canti-levered care”)
- Beds and chairs that provide the opportunity for staff and visitors to sit in a normal conversational relationship with patients in bed
- Beds that provide arm support for caregivers during long-term care procedures such as spoon-feeding a patient
- Devices for gripping a patient’s body that are dignified and safe for both the caregiver and the patient
- Universal sling and lift pieces that reduce the challenges of storing and finding the correct item and using it with a patient



- Beds that accommodate sequential compression devices (SCDs) and bring them into position with limited caregiver effort
- Overhead lifts that are compatible with ceiling-mounted equipment and have a residential appearance
- Overhead lift vests that permit use of normal clothing during toileting
- A variety of motorized floor-based lift or stand-and-move devices that make use on carpeting easier for caregivers
- Floor-based lifts with narrow support platforms that can be used in narrow doorways and spaces
- Beds, chairs, and toilets that incorporate PHAM capability to reduce dependence on specialized equipment
- Patient support platforms that provide rocking and continuous motion to maintain normal body functions
- Patient support surfaces that perform omnidirectional horizontal translation
- Overhead track systems throughout a care environment that continuously support a patient in a standing position and bear all or part of a patient's weight
- Sterile quick-disconnect/reconnect IV tubing, catheters, etc., that allow a patient to ambulate untethered from lines restraining movement

#### **Future Developments in Technology**

- Floor surfaces that reduce or absorb sufficient impact to prevent fractures as a result of falls
- Intuitive controls that give the patient a greater role in directing the use of handling, movement, and mobilization technology
- Exoskeletal devices that multiply the physical strength of caregivers as they perform manual lifting and carrying functions
- Exoskeletal devices that supplement and enhance a patient's physical capabilities for movement and mobility. Programmable devices would be the next level.
- Robotic caregivers

Ultimately, our vision is care facilities in which patients maintain or increase their physical functioning and weight-bearing capacity during their stay and caregivers remain free of work-related injury throughout their career.

# CHAPTER 6

## Patient Handling and Movement Resources

The material in this chapter is presented as sources for further information. Many of these references are also cited throughout this white paper as sources for the information provided herein.

### General

Baptiste, A. "Safe Client Movement and Handling" in *Working Safely in Health Care, A Practical Guide*, edited by D. Fell-Carlson. New York: Delmar Learning, Thomson Corporation (2008).

Matz, M., "Back Injury Prevention in Health Care" in *Handbook of Modern Hospital Safety*, 2nd ed., edited by W. Charney. New York: CRC Press, Taylor & Francis Group (2010).

Nelson, A. L. et al. "Evidence-based Interventions for Patient Care Ergonomics" in *Handbook of Human Factors and Ergonomics in Health Care and Patient Safety*, edited by P. Carayon. Mahwah, NJ: Lawrence Erlbaum Associates, Publishers (2007), pp. 323–45.

Nelson, Audrey; Kathleen Motacki; and Nancy Nivison Menzel. *The Illustrated Guide to Safe Patient Handling and Movement*. New York: Springer Publishing Company (2009).

"The authors present the Evidence-Based Safe Patient Handling Program, a practical system of guidelines to help reduce caregiver and patient injuries during patient handling. Each chapter explains how to apply the program to specific clinical settings, such as medical and surgical, critical care, pediatrics, labor and delivery, rehabilitation settings, the perioperative suite, and nursing homes."

Nelson, Audrey, PhD, RN, FAAN, ed. *Safe Patient Handling and Movement: A Practical Guide for Health Care Professionals*. New York: Springer Publishing Company (2006).

"This book presents best practices in safe patient handling and movement. Caregiver safety approaches include:

- Evidence-based standards for safe patient movement and prevention of musculoskeletal injuries
- An overview of available equipment and technology
- Architectural designs for ergonomically safe patient care space
- Institutional policies, such as use of lift teams"

### Design Guidance

ARJO. *Guidebook for Architects and Planners*, 2nd ed. ARJO Hospital Equipment AB (2005). For a copy of this book, contact ARJOHuntleigh at [info@arjousa.com](mailto:info@arjousa.com).

Bottomley, Gryan, and Associates. "The Victoria Hospital Industrial Association (VHIA) Design Advisory Service: Final Report and Evaluation." Melbourne, Vic. (Australia): WorkSafe Victoria (September 2005).

This report demonstrates that the design of workplaces in the health care industry is critical to achieving sustained improvements in occupational health and safety. Introduction of better designs can reduce risks to health and safety by identifying and addressing issues at the earliest point. Retrieved from [www.worksafe.vic.gov.au/wps/wcm/connect/wsinternet/WorkSafe/Home/Forms+and+Publications/Educational+Material/VHIA+Design+Advisory+Service+Report](http://www.worksafe.vic.gov.au/wps/wcm/connect/wsinternet/WorkSafe/Home/Forms+and+Publications/Educational+Material/VHIA+Design+Advisory+Service+Report).

Villeneuve, J. "Physical Environment for Provision of Nursing Care: Design for Safe Patient Handling" in *Safe Patient Handling and Movement: A Practical Guide for Health Care Professionals*, edited by A. Nelson. New York: Springer Publishing Company, Inc. (2006).

Worksafe Victoria. *Designing Workplaces for Safer Handling of People: For Health, Aged Care, Rehabilitation and Disability Facilities*, 3rd ed. Melbourne, Vic. (Australia): Victorian WorkCover Authority (September 2007).

Formerly titled "Designing workplaces for safer handling of patients and residents," this publication is written for planners, facility managers, and direct care staff. It is intended for those who have design and layout of a current workplace contributing to injuries, organizations designing new facilities or planning renovations, and for workers involved in the planning process for a workplace. Retrieved from [www.worksafe.vic.gov.au/wps/wcm/connect/d39b9b004071f551a67efee1fb554c40/VWA531.pdf?MOD=AJPERES](http://www.worksafe.vic.gov.au/wps/wcm/connect/d39b9b004071f551a67efee1fb554c40/VWA531.pdf?MOD=AJPERES).

## **Clinical Guidance**

### **General**

American Nurses Association. "Safe Patient Handling and Movement" presentation for nursing students. [www.cdc.gov/niosh/review/public/safe-patient/patienthandling2.html](http://www.cdc.gov/niosh/review/public/safe-patient/patienthandling2.html).

This is a segment of the ANA "Handle with Care" Campaign.

American Physical Therapy Association. "Strategies to Improve Patient and Health Care Provider Safety in Patient Handling and Movement Tasks: A Collaborative Effort of the American Physical Therapy Association, Association of Rehabilitation Nurses, and Veterans Health Administration."

Originally published in *PT Magazine* (April 2005), this piece is now posted at [www.apta.org/AM/Template.cfm?Section=Home&CONTENTID=18516&TEMPLATE=/CM/HTMLDisplay.cfm](http://www.apta.org/AM/Template.cfm?Section=Home&CONTENTID=18516&TEMPLATE=/CM/HTMLDisplay.cfm).

Association of periOperative Registered Nurses Workplace Safety Taskforce. *Safe Patient Handling and Movement in the Perioperative Setting*. Denver: AORN (2007). The AORN Guidelines can be purchased from [www.aornbookstore.org/product/product.asp?sku=MAN167&mscssid=KA8KPFTXNHFW8HXVNCDFNM3XJP0W4HXF](http://www.aornbookstore.org/product/product.asp?sku=MAN167&mscssid=KA8KPFTXNHFW8HXVNCDFNM3XJP0W4HXF).

National Association of Orthopaedic Nurses. "Safe Patient Handling and Movement in the Orthopaedic Setting." [www.orthonurse.org/ResearchandPractice/SafePatientHandling/ta/bid/403/Default.aspx](http://www.orthonurse.org/ResearchandPractice/SafePatientHandling/ta/bid/403/Default.aspx).

Occupational Safety and Health Administration. "Guidelines for Nursing Homes: Ergonomics for the Prevention of Musculoskeletal Disorders." [www.osha.gov/ergonomics/guidelines/nursinghome/final\\_nh\\_guidelines.html](http://www.osha.gov/ergonomics/guidelines/nursinghome/final_nh_guidelines.html).

WorkSafe BC. *Patient Handling in Small Facilities: A Companion Guide to Handle with Care*. Workers' Compensation Board of British Columbia (2006). [www.worksafebc.com/publications/health\\_and\\_safety/by\\_topic/assets/pdf/patient\\_handling\\_small\\_facilities.pdf](http://www.worksafebc.com/publications/health_and_safety/by_topic/assets/pdf/patient_handling_small_facilities.pdf).

### **Patient Care Ergonomic Evaluation Process**

Fragala, G. *Ergonomics: How to Contain On-the-Job Injuries in Health Care*. Chicago: Joint Commission (1996).

Ergonomics Technical Advisory Group. *Patient Care Ergonomics Resource Guide: Safe Patient Handling and Movement*, edited by A. Nelson. Tampa: Veterans Administration Patient Safety Center of Inquiry (2001). Available at [www.visn8.va.gov/PatientSafetyCenter/safePtHandling](http://www.visn8.va.gov/PatientSafetyCenter/safePtHandling).

Matz, M. "Patient handling (lifting) equipment coverage & space recommendations." Internal VHA document presented to Director, VHA, Occupational Health Program (2007).

Nelson, A., ed. *Safe Patient Handling and Movement: A Practical Guide for Health Care Professionals* New York: Springer Publishing Company, Inc. (2006).

Shackel, Brian, and Simon J. Richardson, eds. *Human Factors for Informatics Usability*. Cambridge: Cambridge University Press (1991). Retrieved 10/11/09 from [http://books.google.com/books?id=KSHrPgLIMJIC&pg=PA3&lpg=PA3&dq=shackel++ergonomics+defined&source=bl&ots=ITSrLRXYy8&sig=GQ0ybVDGZiDac-KNFLXTEOZVepU&hl=en&ei=YZnSSqLaL4Kntgej0KTwAw&sa=X&oi=book\\_result&ct=result&resnum=1&ved=0CAwQ6AEwAA#v=onepage&q=&f=false](http://books.google.com/books?id=KSHrPgLIMJIC&pg=PA3&lpg=PA3&dq=shackel++ergonomics+defined&source=bl&ots=ITSrLRXYy8&sig=GQ0ybVDGZiDac-KNFLXTEOZVepU&hl=en&ei=YZnSSqLaL4Kntgej0KTwAw&sa=X&oi=book_result&ct=result&resnum=1&ved=0CAwQ6AEwAA#v=onepage&q=&f=false).

## **VA Toolkits/Resources**

The VHA documents listed below can be found at [www.visn8.va.gov/PatientSafetyCenter/safePtHandling](http://www.visn8.va.gov/PatientSafetyCenter/safePtHandling).

- Technology Resource Guide
- Sling Toolkit
- Bariatric Toolkit
- Safe Patient Handling Guidebook for Facility Champions/Coordinators
- Safe Patient Handling Unit Binder for Peer Leaders and Staff
- Algorithms for Safe Patient Handling and Movement
- No Lift Policy Draft
- Comprehensive Safe Patient Handling Bibliography
- Safety Huddle
- Patient Handling Equipment: Making Recommendations and Product Selections

## **Web Links**

American Nurses Association, Handle with Care Program: <http://nursingworld.org/MainMenuCategories/OccupationalandEnvironmental/occupationalhealth/handlewithcare.aspx>.

LIKO Safe Lifting Portal: [www.liko.com/web/frameset.asp?qadwords=&toggle=&topnumber=2&market=&marketid=135&pageid=4626&menuid=1694](http://www.liko.com/web/frameset.asp?qadwords=&toggle=&topnumber=2&market=&marketid=135&pageid=4626&menuid=1694)

Occupational Health and Safety Agency for Health Care in British Columbia (includes safe patient handling chapters): [www.hsa.ca/occupational\\_health\\_and\\_safety/OHS\\_BC\\_ceiling\\_lift.pdf](http://www.hsa.ca/occupational_health_and_safety/OHS_BC_ceiling_lift.pdf)

Safe Patient Handling in Washington State: [www.washingtonsafepatienthandling.org/resources.html](http://www.washingtonsafepatienthandling.org/resources.html)

VA Patient Safety Center, Safe Patient Handling Web page: [www.visn8.va.gov/PatientSafetyCenter/safePtHandling](http://www.visn8.va.gov/PatientSafetyCenter/safePtHandling).

For more links, enter “safe patient handling” or “patient care ergonomics” into an Internet search engine.

## **Selected Journal Articles**

### **Bariatric Design**

Muir, M., and L. Haney. “Designing space for the bariatric resident.” *Nursing Homes/Long Term Care Management*, November 2004:25–28.

Muir, M., and L. Haney. “Ergonomics and the Bariatric Patient.” *The Director* 12(3):143–46 (2004).

### **Biomechanics/Ergonomics**

Hignett, S. “Systematic review of patient handling activities starting in lying, sitting, and standing positions.” *Journal of Advanced Nursing* 41(6):545–52 (2003).

Hignett, S., et al. *Evidence-Based Patient Handling: Tasks, Equipment and Interventions*. New York: Routledge (2003).

Waters, T. R. “When is it safe to manually lift a patient?” *American Journal of Nursing* 107(6):40–45 (2007).

### **Design**

Hignett, S., and J. Arch. “Ensuring bed space is right first time.” *Health Estate Journal*, February 2008: 29–31.

Hignett, S., and E. Keen. “Determining the space needed to operate a mobile and an overhead patient hoist.” *Professional Nurse* 20(7):40–2 (2005).

**Equipment/Slings**

Baptiste, A.; M. McCleery, M. Matz; and C. Evitt. "Evaluation of Sling Use for Patient Safety." *Rehabilitation Nursing*, Jan.-Feb. 2008.

**Patient Assessment for Selecting Appropriate Equipment**

Nelson, A. et al. "Algorithms for Safe Patient Handling and Movement." *American Journal of Nursing* 103(3):32-34 (2003).

**Peer Leaders**

Knibbe, J.; N. Knibbe, and A. M. Klaassen. "Safe patient handling program in critical care using peer leaders: lessons learned in the Netherlands." *Critical Care Nursing Clinics of North America* 19(2):205-11 (2007).

**Program Implementation**

Collins J., et al. "An evaluation of a 'best practices' musculoskeletal injury prevention program in nursing homes." *Injury Prevention* 10:206-11 (2004).

Evanoff, B.; et al. "Reduction in injury rates in nursing personnel through introduction of mechanical lifts in the workplace." *American Journal of Industrial Medicine* 44:451-57 (2003).

Hignett, S., et al. "Evidence-based patient handling: systematic review." *Nursing Standard* 17(33), 33-36 (2003).

Nelson, A. L. et al. "Development and Evaluation of a Multifaceted Ergonomics Program to Prevent Injuries Associated with Patient Handling Tasks." *Journal of International Nursing Studies* 43:717-33 (2006).

Owen B. D.; K. Keene; and S. Olson. "An ergonomic approach to reducing back/shoulder stress in hospital nursing personnel: A five-year follow up." *International Journal of Nursing Studies* 39:295-302 (2002).

Trinkoff, A. M.; B. Brady; and K. Nielsen. "Workplace prevention and musculoskeletal injuries in nurses." *Journal of Nursing Administration* 33(3):153-58 (2003).

Yassi, A., et al. "A randomized controlled trial to prevent patient lift and transfer injuries of health care workers." *Spine* 26(16):1739-46 (2001).

**Resident/Patient Safety**

Nelson, A.L., et al. "Link Between Safe Patient Handling and Quality of Care." *Rehabilitation Nursing* 33(1):33-41 (2008).

# APPENDICES

---

# APPENDIX A

## High-Risk Manual Patient Handling Tasks by Clinical Area

### **Nursing Home or Other Long-Term Care Facility**

- Transferring a patient between toilet and chair
- Transferring a patient between chair and bed
- Transferring a patient from bathtub to chair
- Transferring a patient from chair lift to chair
- Weighing a patient
- Lifting a patient up in bed
- Repositioning a patient in bed from side to side
- Repositioning a patient in a chair
- Changing an absorbent pad
- Making an occupied bed
- Undressing a patient
- Tying supports
- Feeding a bedridden patient
- Making an unoccupied bed

### **Critical Care Units**

- Transporting a patient in a bed or stretcher, frequently with heavy monitors and multiple lines
- Laterally transferring a patient from bed to stretcher
- Lifting a patient to the head of a bed
- Transferring a patient on and off a cardiac chair
- Repositioning a patient in bed from side to side
- Making an occupied bed
- Moving heavy equipment and accessing electrical outlets
- Providing patient handling tasks in a crowded area, where multiple lines and monitoring equipment force caregivers into awkward positions
- Performing cardiopulmonary resuscitation or other procedures when many team members are present and it is impossible to have the bed at the right height for every staff member
- Applying anti-embolism stockings

### **Medical/Surgical Units**

- Transferring a patient from bed to chair or stretcher
- Moving an occupied bed or stretcher

- Making an occupied bed
- Bathing a confused or totally dependent patient
- Lifting a patient up from the floor
- Weighing a patient
- Applying anti-embolism stockings
- Repositioning a patient in bed
- Making extensive dressing changes

### **Operating Room**

- Standing for long periods of time
- Adopting unnatural positions in order to work effectively or leaning over a patient for protracted periods
- Lifting and holding a patient's extremities
- Holding retractors for extended periods of time
- Transferring a patient on and off OR beds
- Reaching, lifting, and moving equipment
- Repositioning a patient in an OR bed

### **Home Care**

- Providing patient care in a bed that is not height-adjustable
- Providing care in a crowded area, forcing awkward positions
- Toileting and transfer tasks without proper lifting aids
- Having no assistance for tasks

### **Psychiatry**

- Restraining a patient
- Escorting/toileting/dressing a confused or combative patient
- Toileting a confused or combative patient
- Dressing a confused or combative patient
- Picking a patient up from the floor
- Bathing/showering a confused or combative patient
- Performing bed-related care

**Rehabilitation/Spinal Cord Injury Units**

- Transferring a patient from toilet to chair
- Transferring a patient from wheelchair to bed
- Repositioning a patient to the head of a bed, or side to side
- Repositioning a patient in a wheelchair
- Making an occupied bed
- Dressing/undressing a patient
- Feeding a bedridden patient
- Ambulating a patient at high risk for falls
- Showering a patient or providing a bed bath
- Applying anti-embolism stockings

**Trauma/Emergency** (limited research regarding high-risk tasks)

- Transferring patients into and out of personal vehicles

**Orthopedic Units**

- Turning an orthopedic patient in bed (side to side)
- Vertically transferring a postoperative total hip replacement patient
- Vertically transferring a patient with an extremity cast/splint
- Ambulating a patient
- Lifting or holding a limb with or without a cast or splint

**Note:** Except for the section on orthopedic units, the information for this appendix is adapted from A. Nelson, "Variations in high-risk patient handling tasks by practice setting," in *Handle with Care: Safe Patient Handling and Movement*, A. L. Nelson, ed. (New York: Springer Publishing Company, 2006). The information for orthopedic units is from National Association of Orthopaedic Nurses, "Safe patient handling in orthopaedic nursing," *Orthopaedic Nursing*, Supplement to 28, no. 2 (2009). The latter is available at [www.orthopaedicnursing.com](http://www.orthopaedicnursing.com).



# APPENDIX B

## Legislative Report

The information in this appendix is current as of January 2010; to learn the current status of bills in Congress, paste the bill number and title into an Internet search engine.

### Federal Legislation

#### **HR 2381: Nurse and Patient Safety and Protection Act of 2009**

HR 2381 remains in committee. This bill for safe patient handling was originally introduced on September 26, 2006, as HR 6182: Nurse and Patient Safety and Protection Act of 2006 by U.S. Representative John Conyers Jr. (D-MI). It called for an amendment of the Occupational Safety and Health Act of 1970 to reduce injuries to patients, nurses, and other health care providers with a safe patient handling standard.

Representative Conyers reintroduced the bill as HR 2381: Nurse and Patient Safety and Protection Act of 2009 on May 13, 2009. HR 2381 would “direct the Secretary of Labor to issue an occupational safety and health standard to reduce injuries to patients, direct-care registered nurses, and other health care providers by establishing a safe patient handling standard.”

If HR 2381 is successful, a federal safe patient handling standard, calling for “all health care facilities” to comply, will be enacted “to prevent musculoskeletal disorders for direct-care registered nurses and other health care providers working in health care facilities. This standard shall require the elimination of manual lifting of patients by direct-care registered nurses and other health care providers, through the use of mechanical devices, except during a declared state of emergency.”

HR 2381 was referred on May 13, 2009, to the Committee on Education and Labor, the Committee on Energy and Commerce, and the Ways and Means Committee. On June 11, 2009, it was referred to the Subcommittee on Workforce Protections.

#### **S1788: Nurse and Health Care Worker Protection Act of 2009**

S1788 was introduced in the U.S. Senate by Al Franken (D-MN) on October 15, 2009. This bill requires the Secretary of Labor to “propose a standard on safe patient handling and injury prevention” to “prevent musculoskeletal disorders for direct-care registered nurses and all other health care workers handling patients in health care facilities.”

The standard would require the use of engineering controls to lift patients and the elimination of manual lifting of patients with the use of mechanical devices, except where patient care may be compromised. In summary, it would also require health care employers to (1) develop and implement a safe patient handling and injury prevention plan, (2) provide workers with training on safe patient handling and injury prevention, and (3) post a uniform notice that explains the standard and procedures for reporting patient handling-related injuries. It would require the Secretary to conduct unscheduled inspections to ensure compliance with safety standards.

The bill allows health care workers to (1) refuse to accept an assignment in a health care facility that violates safety standards or for which such worker has not received required training and (2) file complaints against employers who violate this act. It prohibits employers from taking adverse actions against any health care worker who in good faith reports a violation, participates in an investigation or proceeding, or discusses violations. It authorizes health care workers who have been discharged, discriminated against, or retaliated against in violation of this act to bring legal action for reinstatement, reimbursement of lost compensation, attorneys’ fees, court costs, and other damages. The Secretary of Health and Human Services (HHS) is required to establish a grant program for purchasing safe patient handling and injury prevention equipment for health care facilities.

S1788 was assigned to the Senate Health, Education, Labor, and Pensions committee on October 15, 2009.

## **State Laws**

Nine states have passed legislation pertaining to safe patient and/or resident handling. Seven of the nine directly require development of safe patient handling policies and/or implementation of safe patient handling programs and/or use of mechanical patient lifting equipment, with variations in the scope of the requirements. The two remaining states lend support to efforts for safe patient and/or resident handling.

One state—**Hawaii**—has adopted a resolution.

Seven states—**Texas, Washington, Rhode Island, Maryland, Minnesota, Illinois, and New Jersey**—have passed legislation requiring safe patient and/or resident handling policies and/or programs and/or lifting equipment, with much variation in scope among the different state laws.

Two states—**Ohio** and **New York**—have passed legislation that does not directly require, but is supportive of, safe patient and/or resident handling. Ohio will provide interest-free loans to nursing homes wishing to implement lift equipment, and New York requires a demonstration project on safe patient handling.

Of particular interest is the difference among states in addressing the safe handling of hospital patients and/or nursing home residents. Ideally, legislation should cover the safe handling of dependent persons across all health care settings.

A short comparison of the states, in alphabetical order, is provided. For additional detail, refer to the supporting links.

### **Hawaii**

HCR 16 (April 24, 2006) calls for safeguards in health care facilities to minimize musculoskeletal injuries to nurses and for the State Legislature to support policies in the American Nurses Association's "Handle with Care" campaign. HCR 16 states that in 2005, the Council of State Governments' Health Capacity Task Force adopted and supported the policies contained in the ANA "Handle with Care" campaign and asked member states to also support the campaign. Recognizing

that musculoskeletal disorders are the leading occupational health problem plaguing nurses, HCR 16 says, "Be it resolved . . . that the Legislature of the State of Hawaii supports the policies contained in the American Nurses Association's 'Handle with Care' campaign." **Note:** Does not require a safe patient handling policy or program or use of patient lift equipment.

See [www.capitol.hawaii.gov/session2006/Bills/HCR16\\_.pdf](http://www.capitol.hawaii.gov/session2006/Bills/HCR16_.pdf).

### **Illinois**

HB 2285 (August 13, 2009). Public Act 96-0389 requires that state mental health centers, state developmental centers, and the University of Illinois Hospital comply with these provisions, effective January 1, 2010. The law requires a policy that will identify, assess, and develop strategies to control the risk of injury to patients/residents, nurses, and other health care workers associated with lifting, transferring, repositioning, or movement of a patient/resident. Restriction of lifting must be achieved to the extent feasible with existing equipment and aids; manual handling or movement of all or most of the patient's body weight is to be done only during emergency, life-threatening, or otherwise exceptional circumstances. Some other provisions include staff education, staff training, and a procedure for a nurse to refuse to perform or be involved in handling or movement that the nurse believes in good faith will expose the patient/resident, nurse, or other health care worker to an unacceptable risk of injury.

See [www.ilga.gov/legislation/publicacts](http://www.ilga.gov/legislation/publicacts).

### **Maryland**

HB 1137 and SB 879 (April 10, 2007) define "safe patient lifting" as the "use of mechanical lifting devices by hospital employees, instead of manual lifting, to lift, transfer, and reposition patients." Hospitals are required to develop a safe patient lifting committee with an equal number of managers and employees by December 1, 2007, and a safe patient lifting policy to reduce employee injuries from patient lifting by July 1, 2008. Consideration is to be given to patient handling hazard assessment; enhanced use of mechanical lifting devices; development of

specialized lift teams; training programs for safe patient lifting; incorporating space and construction design for mechanical lifting devices in architectural plans; and evaluating the effectiveness of the safe lifting policy. **Note:** Covers hospitals only, *not* nursing homes. Covers “hospital employees” and thus not limited to nurses.

For the text of HB 1137, see [http://mlis.state.md.us/2007RS/chapters\\_noln/Ch\\_57\\_hb1137T.pdf](http://mlis.state.md.us/2007RS/chapters_noln/Ch_57_hb1137T.pdf). For the text of SB 879, see [http://mlis.state.md.us/2007RS/chapters\\_noln/Ch\\_56\\_sb0879T.pdf](http://mlis.state.md.us/2007RS/chapters_noln/Ch_56_sb0879T.pdf).

### Minnesota

HF 712 and SF 828 passed within HF 122 (May 25, 2007). Every licensed health care facility (including hospitals, outpatient surgical centers, and nursing homes) is required to have a safe patient handling program, with a safe patient handling committee and a policy to minimize manual lifting of patients by nurses and other direct patient care workers by utilizing safe patient handling equipment, rather than people, to transfer, move, and reposition patients and residents in all health care facilities. The program will address acquiring adequate, appropriate, safe patient handling equipment; training; remodeling and construction consistent with program goals; and evaluations of the program. Financial assistance will include matching grants and development of ongoing funding sources to acquire and provide training on safe patient handling equipment, including low-interest loans, interest-free loans, and federal, state, or county grants, plus a special workers’ compensation fund of \$500,000 for safe patient handling grants. The Minnesota State Council on Disability shall convene a work group to study the use of safe patient handling equipment in unlicensed outpatient clinics, physician offices, and dental settings. **Note:** Covers hospitals, surgical centers, and nursing homes. Covers nurses and “other direct patient care workers.”

See HF 122 at [www.leg.state.mn.us/leg/legis.asp](http://www.leg.state.mn.us/leg/legis.asp). Language in three areas: (1) grant funding Art 1, Sec 6, Sub 3, pp. 25–26; (2) main body of wording Art 2, Sec 23. 182.6551 to Sec 25. 182.6553, pp. 48–51; and (3) study ways for workers’ compensation insurers to recognize

compliance in premiums and for ongoing funding Art 2, Sec 36, and work groups on safe patient handling and equipment Sec 37, pp. 58–59.

### New York

A7641 and S4929 (October 18, 2005). Created a two-year “Safe Patient Handling Demonstration Program” to establish safe patient handling programs and collect data on nursing staff and patient injury with patient handling, manual versus lift equipment, in order to describe best practices for health and safety of health care workers and patients. **Note:** Does not require health care facilities to implement safe patient handling policies and programs.

See <http://assembly.state.ny.us> and [www.senate.state.ny.us](http://www.senate.state.ny.us).

A7836 (July 3, 2007) extends the demonstration program for two years to research the effect of safe patient handling programs and to build upon existing evidence-based data, with the goal of designing best practices for safe patient handling in health care facilities. It also establishes specifications for safe patient handling programs. **Note:** Does not require implementation of safe patient handling policies and programs.

For summary text, see <http://assembly.state.ny.us/leg/?bn=A07836>.

### New Jersey

SB 1758 and AB 3028 (January 3, 2008) cover general and special hospitals, nursing homes, state developmental centers, and state and county psychiatric hospitals. Each facility establishes a safe patient handling committee, with at least 50 percent of the members’ health care workers representing disciplines employed by the facility. A safe patient handling program and policy on all units and all shifts is required as well as a plan for prompt access to patient handling equipment; posting the policy in a location easily visible to staff, patients, and visitors (to minimize unassisted patient handling); and includes a statement on the right of a patient to refuse assisted patient handling. “Assisted patient handling” means the use of mechanical patient handling equipment, including, but not limited to, electric beds, portable base and ceiling track-mounted full body sling lifts, stand assist lifts, and mechanized lateral

transfer aids; and patient handling aids, including, but not limited to, gait belts with handles, sliding boards, and surface friction-reducing devices. There shall be no retaliatory action against any health care worker who refuses a patient handling task due to reasonable concern about worker or patient safety or the lack of appropriate and available patient handling equipment. Bills include recommendations for a capital plan to purchase equipment necessary to carry out the policy, which takes into account the financial constraints of the facility. **Note:** Covers hospitals, nursing homes, developmental centers, and psychiatric hospitals. Covers “health care workers,” so not limited to nurses.

For the text of the New Jersey Safe Patient Handling Act, see [www.njleg.state.nj.us/2006/Bills/PL07/225\\_PDF](http://www.njleg.state.nj.us/2006/Bills/PL07/225_PDF).

### Ohio

Ohio passed HB 67 (March 21, 2005) to create a workers’ compensation fund for interest-free loans to nursing homes for lift equipment and for implementation of “No Manual Lifting of Residents” policies. **Note:** Does not require nursing homes to purchase and implement lift equipment or to develop safe resident handling policies and programs. Offers interest-free loans for lift equipment to nursing homes but not to hospitals.

For text, scroll to Sec. 4121.48 at [www.legislature.state.oh.us/bills.cfm?ID=126\\_HB\\_67\\_EN](http://www.legislature.state.oh.us/bills.cfm?ID=126_HB_67_EN).

### Rhode Island

H7386 and S2760 (July 7, 2006) require hospitals and nursing facilities to achieve maximum reasonable reduction of manual lifting, transferring, and repositioning of patients and residents except in emergency, life-threatening, or exceptional circumstances. As a condition of licensure, health care facilities shall establish a safe patient handling committee chaired by a professional nurse with at least half the members’ non-managerial employees providing direct patient care and a safe patient handling program and policy for all shifts and units. An employee may report, without fear of discipline or adverse consequences, being required to perform patient handling believed in good faith to expose the patient and/or employee to an unacceptable risk

of injury. These reportable incidents shall be included in the facility’s annual performance evaluation. Availability and use of safe patient handling equipment in new space or renovation is to be considered, with input from the community to be served. Legislative findings include that safe patient handling can reduce patient skin tears threefold. **Note:** Covers both hospitals and nursing facilities. Covers “employees,” so not limited to nurses.

For text of H7386, see [www.rilin.state.ri.us/Billtext/BillText06/HouseText06/H7386Aaa.pdf](http://www.rilin.state.ri.us/Billtext/BillText06/HouseText06/H7386Aaa.pdf). For S2760, see [www.rilin.state.ri.us/Billtext/BillText06/SenateText06/S2760A.pdf](http://www.rilin.state.ri.us/Billtext/BillText06/SenateText06/S2760A.pdf).

### Texas

SB 1525 (June 17, 2005). Texas was the first state to require both hospitals and nursing homes to establish a policy for safe patient handling and movement. The goal is to control the risk of injury to patients and nurses; evaluate alternative methods to manual lifting, including equipment and patient care environment; restrict, to the extent feasible with existing equipment, manual handling of all or most of a patient’s weight to emergency, life-threatening, or exceptional circumstances; and allow nurses to refuse to perform patient handling tasks believed in good faith to involve unacceptable risks of injury to a patient or nurse. **Note:** Covers both hospitals and nursing homes. Requires safe patient handling policy only. Does not require safe patient handling program or provision and use of lift equipment. Specifies nurses. Does *not* cover nurse assistants.

Enrolled text: [www.capitol.state.tx.us/tlodocs/79R/billtext/html/SB01525F.htm](http://www.capitol.state.tx.us/tlodocs/79R/billtext/html/SB01525F.htm).

### Washington

HB 1672 (March 22, 2006). Washington was the first state to mandate provision of lift equipment by hospitals and to offer financial assistance with implementation by tax credits and reduced workers’ compensation premiums. Hospitals must establish a safe patient handling committee with at least half the members’ frontline non-managerial employees providing direct patient care, a safe patient handling program, and policy for all shifts and units. Hospitals may choose either one readily available lift per acute care unit

on the same floor, one lift for every ten acute care inpatient beds, or lift equipment for use by specially trained lift teams. Employees may refuse without fear of reprisal patient handling activities believed in good faith to impose an unacceptable risk of injury to an employee or patient. With hospital construction or remodeling, the feasibility of incorporating patient handling equipment is to be considered, or of designing to incorporate at a later date. **Note:** Covers hospitals only. Does *not* cover nursing homes. Provides financial assistance to implement lift equipment and programs. Covers “employees,” which would include nurse assistants and other health care workers, not limited to nurses only.

Enrolled text: [www.leg.wa.gov/pub/billinfo/2005-06/Pdf/Bills/House%20Passed%20Legislature/1672-S.PL.pdf](http://www.leg.wa.gov/pub/billinfo/2005-06/Pdf/Bills/House%20Passed%20Legislature/1672-S.PL.pdf).

### **Other State Legislative Efforts**

Eight additional states have introduced legislation with varied results at the date of this report (**California, Connecticut, Florida, Kansas, Massachusetts, Michigan, Missouri, and Nevada**). A short description of the efforts in each state is provided. For details, refer to the links provided.

#### **California**

California introduced safe patient handling legislation every year after Governor Arnold Schwarzenegger vetoed the original legislation in 2004. SB 171, reintroduced in February 2007, was amended in April of that year and passed as the Hospital Patient and Health Care Worker Injury Protection Act. It requires general acute care hospitals to establish a patient protection and health care worker back injury prevention plan; conduct needs assessments to identify patients needing lift teams and lift, repositioning, or transfer devices; use lift teams and lift, repositioning, and transfer devices; and train health care workers on the appropriate use of lift, repositioning, and transfer devices. The bill was passed without funding and referred to the appropriations committee. A companion bill, AB 371, was introduced in the Assembly and referred to the Appropriations Committee. It was amended in

March and April 2007. On September 28, 2008, for the fifth time in as many years, the governor vetoed legislation for safe handling of health care patients in California.

For the amended text of SB 171, see [www.leginfo.ca.gov/pub/07-08/bill/sen/sb\\_0151-0200/sb\\_171\\_bill\\_20070423\\_amended\\_sen\\_v98.pdf](http://www.leginfo.ca.gov/pub/07-08/bill/sen/sb_0151-0200/sb_171_bill_20070423_amended_sen_v98.pdf). For the amended text of AB 371, see [http://info.sen.ca.gov/pub/07-08/bill/asm/ab\\_0351-0400/ab\\_371\\_bill\\_20070423\\_amended\\_asm\\_v97.pdf](http://info.sen.ca.gov/pub/07-08/bill/asm/ab_0351-0400/ab_371_bill_20070423_amended_asm_v97.pdf).

#### **Connecticut**

SB470 (2008) attempts to address a number of different nurse retention issues, including a provision for purchasing lift equipment. There has been no action on the bill since February 26, 2008.

See [www.cga.ct.gov](http://www.cga.ct.gov).

#### **Florida**

Florida reintroduced companion bills for safe patient handling in February 2007; these would have created a new Florida statute for safe patient handling and movement practices, but both bills died in committee on May 4, 2007. S2208 would have required hospitals to adopt a policy for safe movement of patients and would have prohibited hospitals from retaliating or discriminating against employees who, in good faith, reported violations of the act. H1193 would have required hospitals and nursing homes to incorporate patient handling equipment into the construction or remodeling of hospitals or nursing homes and provided credit for equipment purchase.

For S2208 links to history and text, see [www.flsenate.gov](http://www.flsenate.gov). For H1193, see [www.myfloridahouse.gov](http://www.myfloridahouse.gov).

#### **Kansas**

HB 2846 (2008) would have required a safe patient handling policy and program to apply to all “medical” facilities. It is no longer active.

See [www.kslegislature.org/legsrv-legisportal/index.do](http://www.kslegislature.org/legsrv-legisportal/index.do).

#### **Massachusetts**

Massachusetts has pursued legislation for safe patient handling since December 2004. The bill was reintroduced in January 2007 as S1294 and

referred to the committee on Public Health. If passed, it would require every licensed health care facility to implement an evidence-based policy for safe handling and movement of patients and to provide training on use of patient handling equipment and devices, patient care ergonomic assessment protocols, no-lift policies, and patient lift teams. H2052, a companion House bill, was also introduced in January 2007 and referred to the Public Health committee.

On October 24, 2007, both bills were discussed during a public hearing. On February 28, 2008, the House reported favorably and referred the bill to the Health Care Financing committee. On January 6, 2009, the Senate Ways and Means committee took no action.

For history on S1294, see [www.mass.gov/legis/185history/s01294.htm](http://www.mass.gov/legis/185history/s01294.htm); for H2052, see [www.mass.gov/legis/185history/h02052.htm](http://www.mass.gov/legis/185history/h02052.htm). For S1294 text, see [www.mass.gov/legis/bills/senate/185/st01/st01294.htm](http://www.mass.gov/legis/bills/senate/185/st01/st01294.htm); for H2052, see [www.mass.gov/legis/hbillsrch.htm](http://www.mass.gov/legis/hbillsrch.htm).

### Michigan

Introduced in March 2007, Senate Bill 377 would have required hospitals to establish a safe patient handling committee by January 1, 2008, and a safe patient handling program by September 1, 2008. Hospitals could choose one of three options for acquisition of lift equipment by December 31, 2011. The bill was referred to the Committee on Health Policy on March 27, 2007; it died in committee.

SB 377 included provision for employees refusing, without reprisal, to perform patient handling they believe in good faith to be unsafe and specifies that “safe patient handling” means the use of engineering controls, lifting and transfer aids, or assistive devices, by lift teams or other staff, instead of manual lifting for lifting, transferring, and repositioning health care patients and residents.

For SB 377 history, see [www.legislature.mi.gov/\(S\(aei3m12r0ei40i3bjivvhe55\)\)/mileg.aspx?page=getobject&objectname=2007-SB-0377&query=on](http://www.legislature.mi.gov/(S(aei3m12r0ei40i3bjivvhe55))/mileg.aspx?page=getobject&objectname=2007-SB-0377&query=on). For text, see [www.legislature.mi.gov/documents/2007-2008/billintroduced/Senate/htm/2007-SIB-0377.htm](http://www.legislature.mi.gov/documents/2007-2008/billintroduced/Senate/htm/2007-SIB-0377.htm).

### Missouri

HB 1940 (2008) introduced legislation requiring hospitals to establish safe patient handling and movement policy and programs. It was consolidated into HB 1933, but no further action was taken.

See [www.house.mo.gov/billtracking/bills081/bills/HB1940.htm](http://www.house.mo.gov/billtracking/bills081/bills/HB1940.htm) and [www.house.mo.gov/billtracking/bills081/bills/HB1933.htm](http://www.house.mo.gov/billtracking/bills081/bills/HB1933.htm).

### Nevada

AB577, introduced on March 26, 2007, required hospitals and skilled nursing facilities to establish a program and policy for safe handling of patients, including a committee on safe patient handling, annual training for employees on safe handling of patients, annual evaluation of the policy, consideration of incorporation of lifting equipment during construction or remodeling, and annual reports to the Nevada Legislature concerning safe patient handling. After consideration by the Committee on Health and Human Services, on April 23, 2007, AB577 passed the Assembly as amended. After it was moved to the Senate, the bill was referred to the Committee on Human Resources and Education. On May 26, 2007, it was determined no further action was allowed.

For AB577 history, see <https://www.leg.state.nv.us/74th/Reports/history.cfm?DocumentType=1&BillNo=577>. For text with amendments adopted April 23, 2007, see [https://www.leg.state.nv.us/74th/Bills/AB/AB577\\_R1.pdf](https://www.leg.state.nv.us/74th/Bills/AB/AB577_R1.pdf).

*Principal author:* David Soens, PE, AIA

*Contributing author:* Wade Rudolph, CBET, CHFM

### Sources:

American Nurses Association (ANA):

[www.nursingworld.org](http://www.nursingworld.org).

United American Nurses (UAN):

[www.uannurse.org](http://www.uannurse.org).

Work Injured Nurses Group (WING USA):

[www.wingusa.org](http://www.wingusa.org).

# APPENDIX C

## PHAM Equipment Categories

The patient handling and movement (PHAM) equipment categories discussed here are those most commonly used at present; however, not all categories will have a marked effect on design decisions.

To encourage use, the patient handling devices identified with an asterisk (\*) must be stored in accessible and appropriate locations; to accomplish this, consideration must be given to storage space specifications during planning for new construction and renovation projects. Furthermore, space must be provided in patient rooms and/or patient toilet/bath rooms for use of this equipment by one or more caregivers. This space must accommodate a sufficient turning radius in the toilet room, bathroom, patient room, and hallway. Use of bariatric (and therefore larger) variations of these equipment types is essential for protecting caregivers and bariatric patients, so the larger areas required for this equipment must also be considered during planning.

### **Powered Patient Lifting Equipment or Hoists**

Powered patient lifting equipment or hoists come in both overhead and floor-based designs. Caregivers use this equipment to help them lift and transfer patients, mobilize and ambulate patients, reposition patients side to side and up in bed, and lift patient limbs as well as other patient handling tasks. Some lifts can also be used to extract patients/residents from vehicles.

Lifts controlled with a handheld device are powered with a rechargeable battery pack. Presently, the two major categories of powered lifting equipment are full-body sling lifts and sit-to-stand (stand assist) lifts. Full-body sling lifts are further categorized as floor-based lifts, gantry lifts, or overhead lifts (including ceiling-mounted, wall-mounted, and portable lifts). The term “ceiling lift” is generally used in place of “overhead lift” to identify lifts with track systems that are

### **Notes**

1. A variety of terms are used to identify much of the equipment listed in this appendix. The terms used here are those commonly used in the United States.
2. The definitions in this appendix may refer to dependency levels based on physical limitations of patients. (See Table H-1: Physical Dependency Levels of Patient Populations in Appendix H for definitions.)

permanently affixed to the structural component of a ceiling or wall.

### **Full-Body Sling Lifts**

Full-body sling lifts utilize a variety of sling styles to provide total support and assistance for dependent and extensive-assistance patients as well as partial support for patients with some weight-bearing ability. Weight capacities range from around 350 lbs. to 1,200 lbs. for bariatric patients.

Of the three types of full-body sling lifts, ceiling lifts and floor-based lifts are by far the most commonly used. However, research points to significant biomechanical advantages to using ceiling lifts rather than floor-based lifts.<sup>1, 2, 3, 4, 5</sup> In addition, clinical staff generally prefer ceiling lifts because of their greater convenience and accessibility,<sup>6, 7, 8</sup> which leads to increased staff acceptance and thus greater use of ceiling lifts.<sup>9, 10, 11, 12</sup> Most clinical areas also benefit from the variety of usable sling applications available for ceiling lifts.

The real value of lifts to a health care facility is determined by sling usage and availability. A common sling, the *universal or seated sling* (Figure C-1), is used to transfer patients from seated positions to seated positions (e.g., bed to wheelchair, chair, toilet, or commode). *Repositioning slings* (Figure C-2) assist in repositioning patients side to side and up in bed. *Strap slings*, also known as *limb support slings* (Figure C-3), have a variety of helpful functions including limb support and

**Figure C-1:  
Seated Slings**

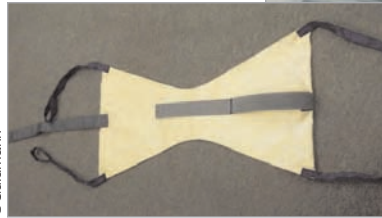

**Figure C-2:  
Repositioning  
Slings**



**Figure C-3: Strap or  
Limb Support Sling**



**Figure C-4:  
Ambulation  
Slings**







**Figure C-5:  
Supine Sling**



©Ergolet



In toilet room (©Ergolet)

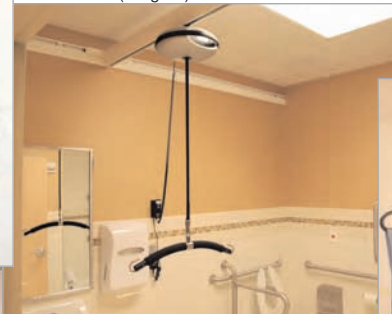

©Liko



a

d



c



f

**Figure C-6: Full-Body Sling Lifts  
Overhead/Ceiling Lifts**

lateral rotation. When attached to an overhead lift, *ambulation slings* (Figure C-4) serve to provide support for those who are in the process of rehabilitating and who have a goal of increasing mobilization capabilities. *Supine slings* (Figure C-5) keep patients in a flat position and are used to lift patients from the floor/ground, off of the bed in order to make the bed, and for lateral transfers and other tasks.

**Overhead lifts** (Figure C-6 a-f). Ceiling-mounted lifts are attached to fixed track systems. The motor/lift traverses a track that is attached to the building infrastructure, usually the I-beam or concrete floor above. Although this type of installation is preferred, structural deficiencies in existing buildings may prevent it. When that is the

case, if possible and appropriate, wall-mounted bracing systems can be used to support the track.

Ceiling motor/lifts are normally permanently attached to the fixed track system; however, some organizations opt to use portable motor/lift systems that can be moved from room to room when needed and attached to existing track in the room. Challenges similar to those encountered with floor-based lifts arise when using this type of portable system, and even though it may seem to be an economical solution, it often is not because staff compliance in using it is often low. Floor space requirements are not an issue with overhead/ceiling lifts, and they are the lift of choice, especially in new construction and in existing buildings with small rooms.



**Figure C-6: Full-Body Sling Lifts**  
Floor-Based Sling Lifts

**\*Floor-based sling lifts** (Figure C-6 g-i). These portable/mobile lifts move along the floor surface on wheels attached to an expandable base for spreading around chairs/wheelchairs. Weight capacities range from around 350 lbs. to 1,000 lbs. for bariatric patients. Accordingly, space requirements vary with weight capacities and the size of the equipment. Obstacles to use of floor-based lifts include accessibility,<sup>13, 14, 15</sup> time to

locate and transport the lift to the patient room, and adequate storage requirements.<sup>16, 17</sup> Flooring characteristics such as flooring materials<sup>18, 19</sup> and thresholds impact the ease of use of this type of rolling equipment.<sup>20</sup>

**\*Gantry lifts** (Figure C-6 j). This type of mobile lift has two vertical side supports and a support bar that extends horizontally between the two side supports. The lift motor traverses across the horizontal bar. The gantry lift is placed over the bed of a patient and functions similarly to a ceiling lift. Usually these lifts are mobile, so they can be moved from room to room when necessary; however, they are not used to transport a patient from a patient room to another room or location. They are often leased but sometimes purchased when storage is adequate. When leased, they are most often used for very obese and bariatric patients when there is no ceiling lift available to move and lift these patients. The gantry lift is not recommended as a substitute for fixed ceiling lifts, but it has advantages over the use of floor-based full-body sling lifts for morbidly obese and bariatric patients.

### Bed/Mattress Patient Handling Features

- Electric/power movement
- Retractable footboard
- Percussion/vibration
- Raised knee platform
- Capillary perfusion enhancement
- Built-in scale
- Adjustable height
- CPR function
- Bariatric accommodation
- Motorized capability
- Lateral rotation therapy
- Others



**Figure C-7:  
Powered Sit-to-  
Stand Lifts**



**Figure C-8:  
Air-Assisted  
Lateral  
Transfer  
Devices**



### Powered Sit-to-Stand (Stand Assist or Standing) Lifts

These powered lifts (Figure C-7) are mobile and move along the floor surface on wheels attached to an expandable base that can spread around chairs/wheelchairs. The lifts are used for patients who can provide some assistance in transferring and ambulating (i.e., those with partial weight-bearing capability). These patients must also have upper body strength, the ability to grasp with at least one hand, and the ability to follow simple instructions. The lifts are used for transfers from seated position to seated position (e.g., bed to wheelchair or commode) and for assistance in dressing, pericare, toileting, and other activities. Sit-to-stand lifts with ambulation capability can also be used for assistance in patient mobilization and ambulation therapy.

Weight capacities range from around 350 lbs. to 1,000 lbs. for bariatric patients, and thus space requirements vary with weight capacities and the size of the equipment. Obstacles to use of floor-based lifts include accessibility of the lift,<sup>21, 22, 23</sup> time needed to locate and transport the lift to the patient room, and storage requirements.<sup>24,25</sup> Architectural details such as the flooring materials<sup>26, 27</sup> and type of threshold impact the ease of use of this type of rolling equipment.<sup>28</sup>

### Lateral Transfer Devices

Lateral transfer devices provide assistance for moving patients horizontally from one flat surface to another (e.g., transfers to/from bed to stretcher to exam or treatment table). These devices minimize frictional resistance and thus decrease the pulling force required to move patients. Some of these devices may also be used for repositioning patients in bed, both up in the bed and laterally side to side. Currently available devices fall into one of three categories—air-assisted, mechanical, or friction-reducing lateral transfer devices.

#### Air-Assisted Lateral Transfer Devices

Air-assisted lateral transfer devices (Figure C-8) float patients on a layer of air from one surface to another and are used not only for lateral transfers but also for repositioning patients up and from side to side in bed. The devices consist of a motorized blower, hose, and mattress with pin holes on the bottom. The blower forces air into the mattress and the air escapes through the holes, providing a layer of air for ease in sliding patients as well as decreasing shear forces on the patient's skin. There is some evidence that the decreased shear force on the skin diminishes the occurrence of skin tears associated with manual patient

**Figure C-9:  
Mechanical  
Lateral  
Transfer  
Device**



©ArjoHuntleigh



©Transmotion Medical

**Figure C-11:  
Transfer Chairs**

handling. Air-assisted devices also provide excellent reduction in force on the spine of a caregiver. Research in a medical intensive care setting found this style of lateral transfer device was preferred over other designs.<sup>29,30</sup>

#### **\*Mechanical Lateral Transfer Devices**

Mechanical devices (Figure C-9) are powered by an electric motor or manual crank. They attach to a draw sheet or something similar and, when energized, pull the patient from one surface to another. Another variation operates by extending a rigid surface under the patient, which is then used to move the patient from place to place.

#### **Friction-Reducing Devices (FRDs)**

FRDs (Figure C-10) are very low-friction sheets or membranes that readily slide across other materials or each other to decrease frictional resistance when manually sliding a patient.<sup>31, 32</sup> Depending on the type of material, some are used for lateral transfers and for repositioning patients up and side to side in bed. Some are designed with one low-friction side and one high-friction side, which reduces the tendency for patients to slide



Slipp® ©Wright Products Inc.



©ArjoHuntleigh

**Figure C-10: Friction-  
Reducing Devices (FRDs)**

down in the bed and/or in a chair/wheelchair. FRDs are especially helpful when inserting and removing patient lift slings underneath large patients.

#### **\*Transfer Chairs**

Transfer chairs (Figure C-11) are used to eliminate the need to perform vertical (seated to seated) transfers. They convert from a chair position to a flat (supine) position in which the patient can be laterally transferred to a bed, exam table, stretcher, or other table.

#### **\*Non-Powered Standing Aids**

Non-powered standing aids are useful for patients who are able to help themselves rise from a sitting to a standing position. The equipment furnishes a secure, steady handle or something similar for patients to grab onto while pulling themselves up. Some aids may be used without the assistance of a caregiver and therefore facilitate independence for the patient. Many styles exist; some are free-standing, and some attach to beds.



©Stryker

**Figure C-12: Stretcher**



©Dane Industries

**Figure C-13: Transport Assistive Device**



©ArjoHurtiteigh

**Figure C-14: Ergonomic Shower Chair**

### Sliding Boards/Devices

Sliding boards/devices function to bridge the space between, for example, a bed and wheelchair or bedside commode. They are used by more independently functioning patients and afford patients a degree of autonomy, since patients can often perform transfers on their own with these devices. However, some patients still require caregiver assistance. The devices are made of a rigid material with a smooth surface for greater ease in moving from one place to another.

### Beds

Beds are also considered patient handling technology. They raise and lower patients to advantageous work heights and can be made coplanar with other surfaces onto which a patient is to be laterally transferred. In emergencies, when time is of the essence, they are used for patient transport.

Some beds and mattresses have features that provide assistance with patient handling tasks (see sidebar) such as lateral rotation therapy, percussion, and bringing patients to a sitting position. In addition, motorized patient beds have become more common. However, the dimensions of many of these motorized beds and bariatric beds are greater than those of standard patient beds, and

this becomes a problem when elevators and doorways are not large enough. (For example, bariatric bed widths can exceed 48" and therefore cannot fit through the typical 48"-wide hospital door.)

### \*Stretchers/Gurneys

Stretchers and gurneys (Figure C-12) with special features can facilitate transporting patients, laterally transferring patients, lifting patients from the floor, and so on. Motorized stretchers or gurneys are especially helpful in facilities with walkways of various levels that require caregivers to push up an incline and limit acceleration when pushing down the incline. Special features important to reducing risk from patient handling include either motorization or a wheel system that helps move and maneuver a non-motorized stretcher. A hydraulic lift or some other powered raising and lowering mechanism can also decrease the ergonomic risk involved in lifting a patient from a low position.

### \*Transport Assistive Devices

Transport assistive devices (Figure C-13) assist caregivers in pushing heavy rolling objects such as beds, wheelchairs, and heavy equipment.<sup>33</sup> These devices are usually battery-powered and attach to the equipment, the head of a bed, or the back of a

wheelchair. To operate them, a caregiver simply steers the device in the right direction. However, when the devices are used with a patient bed, they extend the length of the bed, making them of limited use when beds must be moved between floors unless a device can be located on each floor where one is likely to be needed. Transport assistive devices are especially helpful in facilities with walkways of various levels or whenever caregivers must push patients up an incline or limit acceleration when pushing down an incline.

### \*Ergonomic Shower Chairs

These chairs (Figure C-14) position patients so that staff can easily access a patient's body areas without squatting or excessive bending. Most ergonomic shower chairs are height adjustable and can tilt the patient into a reclining position.

### Endnotes

- 1 W. S. Marras, G. G. Knapik & S. Ferguson, "Lumbar spine forces during manoeuvring of ceiling-based and floor-based patient transfer devices," *Ergonomics* 52, no. 3 (2009): 384-97.
- 2 M. S. Rice, S. M. Woolley & T. R. Waters, "Comparison of required operating forces between floor-based and overhead-mounted patient lifting devices," *Ergonomics* 52, no. 1 (2009): 112-20.
- 3 P. L. Santaguida, M. Pierynowski, C. Goldsmith & G. Fernie, "Comparison of cumulative low back loads of caregivers when transferring patients using overhead and floor mechanical lifting devices," *Clinical Biomechanics* 20 (2005): 906-16.
- 4 A. Nelson, J. Lloyd, C. Gross & N. Menzel, "Preventing nursing back injuries," *AAOHN Journal* 51, no. 3 (2003): 126-34.
- 5 Santaguida et al., "Comparison of cumulative low back loads of caregivers."
- 6 Occupational Health & Safety Agency for Healthcare (OHSAH) in British Columbia, "Ceiling lifts as an intervention to reduce the risk of patient handling injuries: A literature review" (Vancouver, BC, 2006). Retrieved on 7/30/09 from [http://control.ohsah.bc.ca/media/Ceiling\\_Lift\\_Review.pdf#search=%22b%20owen%2C%20patient%20lifts%20ratio%22](http://control.ohsah.bc.ca/media/Ceiling_Lift_Review.pdf#search=%22b%20owen%2C%20patient%20lifts%20ratio%22).
- 7 A. L. Nelson, M. Matz, F. Chen, K. Siddharthan, J. Lloyd & G. Fragala, "Development and evaluation of a multifaceted ergonomics program to prevent injuries associated with patient handling tasks," *Journal of International Nursing Studies* 43 (2006): 717-33.
- 8 D. Daynard, A. Yassi, J. E. Cooper, R. Tate, R. Norman & R. Wells, "Biomechanical analysis of peak and cumulative spinal loads during patient handling activities: A sub-study of a randomized controlled trial to prevent lift and transfer injury health care workers," *Applied Ergonomics* 32 (2001): 199-214.
- 9 Nelson et al. "Development and evaluation of a multifaceted ergonomics program."
- 10 OHSAH, "Ceiling lifts as an intervention to reduce the risk of patient handling injuries."
- 11 Santaguida et al., "Comparison of cumulative low back loads of caregivers."
- 12 Daynard et al., "Biomechanical analysis of peak and cumulative spinal loads during patient handling activities."
- 13 OHSAH, "Ceiling lifts as an intervention to reduce the risk of patient handling injuries."
- 14 Nelson et al. "Development and evaluation of a multifaceted ergonomics program."
- 15 Daynard et al., "Biomechanical analysis of peak and cumulative spinal loads during patient handling activities."
- 16 M. Matz, "Analysis of VA patient handling and movement injuries and preventive programs" (Internal VHA report to Director, VHA, Occupational Health Program, 2007). Retrieved on 8/30/09 from: [http://www1.va.gov/VISN8/PatientSafetyCenter/safePtHandling/Analysis\\_VAPtHndlgInjuries.doc](http://www1.va.gov/VISN8/PatientSafetyCenter/safePtHandling/Analysis_VAPtHndlgInjuries.doc).
- 17 A. Nelson, G. Fragala & N. Menzel, "Myths and facts about back injuries in nursing," *American Journal of Nursing* 103, no. 2 (2003): 32-41.
- 18 Rice et al., "Comparison of required operating forces between floor-based and overhead-mounted patient lifting devices."
- 19 Marras et al., "Lumbar spine forces."
- 20 Matz, "Analysis of VA Patient Handling and Movement Injuries and Preventive Programs."
- 21 OHSAH, "Ceiling lifts as an intervention to reduce the risk of patient handling injuries."
- 22 Nelson et al. "Development and evaluation of a multifaceted ergonomics program."
- 23 Daynard et al., "Biomechanical analysis of peak and cumulative spinal loads during patient handling activities."
- 24 Nelson et al., "Myths and facts about back injuries in nursing."
- 25 Matz, "Analysis of VA Patient Handling and Movement Injuries and Preventive Programs."
- 26 Rice et al., "Comparison of required operating forces between floor-based and overhead-mounted patient lifting devices."
- 27 Marras, "Lumbar spine forces during manoeuvring of ceiling-based and floor-based patient transfer devices."
- 28 Matz, "Analysis of VA Patient Handling and Movement Injuries and Preventive Programs."
- 29 J. Lloyd & A. Baptiste, "Friction-reducing devices for lateral patient transfers: A biomechanical evaluation," *American Association of Occupational Health Nurses* 54, no. 3 (March 2006):113-19.
- 30 A. Baptiste et al. "Friction-reducing devices for lateral patient transfers: A clinical evaluation." *American Association of Occupational Health Nurses* 54, no. 4 (April 2006):173-80.
- 31 J. Lloyd & A. Baptiste, "Friction-reducing devices for lateral patient transfers: A biomechanical evaluation."
- 32 Baptiste et al., "Friction-reducing devices for lateral patient transfers: a clinical evaluation."
- 33 AORN, *Safe Patient Handling and Movement in the Perioperative Setting*, Association of periOperative Nurses.

# APPENDIX D

## Sling Selection Chart

Activity	Sling Choices	Criteria	Special Considerations
Vertical transfers (To/from bed/ wheelchair/ commode/ dependency chair/etc.)	SEATED	Patient can tolerate sitting position and has adequate hip and knee flexion.	<ul style="list-style-type: none"> <li>■ Consider presence of wounds for sling application and patient positioning.</li> <li>■ Consider precautions of total hip replacement patients.</li> </ul>
	STANDING	Patient can grasp and hold handle with at least one hand, has at least partial weight-bearing capability, has upper body strength, and is cooperative and can follow simple commands.	<ul style="list-style-type: none"> <li>■ Consider presence of wounds for sling application and patient positioning.</li> </ul>
Lateral transfers (To/from bed/ stretcher/shower trolley/gurney)	SUPINE	Patient cannot tolerate sitting position and has restricted hip and/or knee flexion. Patient can tolerate supine position.	<ul style="list-style-type: none"> <li>■ Do NOT use if patient has respiratory compromise or if wounds present may affect transfers/positioning.</li> </ul>
Bathing	SUPINE	Patient cannot tolerate sitting position and has restricted hip and/or knee flexion. Patient can tolerate supine position.	<ul style="list-style-type: none"> <li>■ Do NOT use if patient has respiratory compromise or if wounds present may affect transfers/positioning.</li> </ul>
	SEATED	Patient can tolerate sitting position and has adequate hip and knee flexion.	<ul style="list-style-type: none"> <li>■ Consider presence of wounds for sling application and patient positioning.</li> <li>■ Consider precautions of total hip replacement patients.</li> </ul>
	LIMB SUPPORT	Sustained holding of any extremity while bathing in bed.	<ul style="list-style-type: none"> <li>■ Consider wounds, comfort, circulation, neurovascular and joint conditions, if task is of long duration.</li> </ul>
Toileting	SEATED	Patient can tolerate sitting position and has adequate hip and knee flexion.	<ul style="list-style-type: none"> <li>■ Consider presence of wounds for sling application and patient positioning.</li> <li>■ Consider precautions of total hip replacement patients.</li> </ul>
	STANDING	Patient can grasp and hold handle with at least one hand, has at least partial weight-bearing capability, has upper body strength, and is cooperative and can follow simple commands.	<ul style="list-style-type: none"> <li>■ Consider presence of wounds for sling application and patient positioning.</li> </ul>
Repositioning in chair	SEATED	Patient can tolerate sitting position and has adequate hip and knee flexion	<ul style="list-style-type: none"> <li>■ Consider presence of wounds for sling application and patient positioning.</li> <li>■ Consider precautions of total hip replacement patients.</li> </ul>

<b>Activity</b>	<b>Sling Choices</b>	<b>Criteria</b>	<b>Special Considerations</b>
Repositioning up in bed	SUPINE	Patient cannot tolerate sitting position and has restricted hip and/or knee flexion. Patient can tolerate supine position.	<ul style="list-style-type: none"> <li>■ Do NOT use if patient has respiratory compromise or if wounds present may affect transfers/positioning.</li> <li>■ Consider presence of wounds for sling application and patient positioning.</li> <li>■ Consider precautions of total hip replacement patients.</li> <li>■ Do NOT use if patient has respiratory compromise or if wounds present may affect transfers/positioning.</li> </ul>
	SEATED	Patient can tolerate sitting position and has adequate hip and knee flexion.	
	REPOSITIONING	Patient can tolerate supine position.	
Turning a patient in bed	SUPINE	Patient cannot tolerate sitting position and has restricted hip and knee flexion. Patient can tolerate supine position.	<ul style="list-style-type: none"> <li>■ Do NOT use if patient has respiratory compromise or if wounds present may affect transfers/positioning.</li> <li>■ Do NOT use if patient has respiratory compromise or if wounds present may affect transfers/positioning.</li> </ul>
	REPOSITIONING	Patient can tolerate supine position.	
Making an occupied bed	SUPINE	Patient cannot tolerate sitting position and has restricted hip and/or knee flexion. Patient can tolerate supine position.	<ul style="list-style-type: none"> <li>■ Do NOT use if patient has respiratory compromise or if wounds present may affect transfers/positioning.</li> <li>■ Consider presence of wounds for sling application and patient positioning.</li> <li>■ Consider precautions of total hip replacement patients.</li> </ul>
	SEATED	Patient can tolerate sitting position and has adequate hip and knee flexion.	
Functional sit-stand training/support	STANDING	Patient can grasp and hold handle with at least one hand, has at least partial weight-bearing capability, has upper body strength, and is cooperative and can follow simple commands.	<ul style="list-style-type: none"> <li>■ Consider presence of wounds for sling application and patient positioning.</li> </ul>
Dressing	STANDING	Patient can grasp and hold handle with at least one hand, has at least partial weight-bearing capability, has upper body strength, and is cooperative and can follow simple commands.	<ul style="list-style-type: none"> <li>■ Consider presence of wounds for sling application and patient positioning.</li> <li>■ Consider wounds, comfort, circulation, neurovascular and joint conditions, if task is of long duration.</li> </ul>
	LIMB SUPPORT	Sustained holding of any extremity while dressing in bed.	
Pericare	STANDING	Patient can grasp and hold handle with at least one hand, has at least partial weight-bearing capability, has upper body strength, and is cooperative and can follow simple commands.	<ul style="list-style-type: none"> <li>■ Consider presence of wounds for sling application and patient positioning.</li> </ul>



<b>Activity</b>	<b>Sling Choices</b>	<b>Criteria</b>	<b>Special Considerations</b>
Ambulation training and support	WALKING	Partial weight-bearing, level of cooperation, consult doctor and/or therapist for readiness.	<ul style="list-style-type: none"> <li>■ Do NOT use if wounds present that affect transfers and positioning.</li> <li>■ Consider presence of wounds for sling application and patient positioning.</li> </ul>
	STANDING	Patient can grasp and hold handle with at least one hand, has at least partial weight-bearing capability, has upper body strength, and is cooperative and can follow simple commands.	
Wound care/dressing	LIMB SUPPORT	Sustained holding of any extremity while dressing/caring for wounds while patient in bed.	<ul style="list-style-type: none"> <li>■ Consider wounds, comfort, circulation, neurovascular and joint conditions, if task is of long duration.</li> </ul>
Surgical procedures	LIMB SUPPORT	Sustained holding of any extremity while performing surgical procedure in bed.	<ul style="list-style-type: none"> <li>■ Consider wounds, comfort, circulation, neurovascular and joint conditions, if task is of long duration.</li> </ul>
Fall rescue	SUPINE	Patient cannot tolerate sitting position and has restricted hip and/or knee flexion. Need for patient to remain flat. Patient can tolerate supine position.	<ul style="list-style-type: none"> <li>■ Do NOT use if patient has respiratory compromise or if wounds present may affect transfers/positioning.</li> <li>■ Consider presence of wounds for sling application and patient positioning.</li> <li>■ Consider precautions of total hip replacement patients.</li> </ul>
	SEATED	Patient can tolerate sitting position and has adequate hip and knee flexion.	

Adapted from A. Baptiste, M. McCleery, M. Matz & C. Evitt, "Evaluation of sling use for patient safety," *Rehabilitation Nursing* (Jan.–Feb. 2008).

# APPENDIX E

## Patient Care Ergonomic Evaluation Process

The patient care ergonomic (PCE) evaluation process is used to pull together information that can facilitate accurate purchase decisions for patient handling equipment as well as generate recommendations for changes in policies and procedures to improve the safety of the patient care work environment. The following process is adapted from one developed by Guy Fragala, PhD, CSP. Other variations are available (see resources listed at the end of this appendix).

### Introduction to Ergonomics

To understand why an ergonomic evaluation is necessary, a brief introduction to ergonomics may be helpful. Simply put, ergonomics is the study of work. More completely defined by Brian Shackel and Simon Richardson in *Human Factors for Informatics Usability*, it is the scientific study of the relationship between people and the work they do (occupation/job), the tools (equipment) they use in their jobs, and the characteristics of the environment in which they work (workplace). When any of these aspects of a person's job/tasks affects his or her musculoskeletal system, an ergonomic hazard is present. Ergonomic hazards are those stressors, forces, and loads that impact the musculoskeletal system. When the forces exceed the body's biomechanical or physiological limits, injury occurs.

Ergonomics provides a step-by-step approach for ensuring that appropriate technology is in place to reduce musculoskeletal stress and strain and thus to reduce the risk of injury. The following outline, based on one developed by Guy Fragala, PhD, CSP, briefly lays out an ergonomic approach to decreasing the risk of injury.

1. Evaluate jobs and tasks performed:
  - Identify jobs and job tasks that stress body parts beyond limits.
  - Develop solutions to change the demands of these tasks.

### **Please note:**

1. It is important to conduct a PCE evaluation for *all* areas in which patient handling occurs: critical care units, medical/surgical units, radiology/MRI/CT/nuclear medicine suites, therapy areas, labor/delivery suites, outpatient clinics, treatment areas, procedure areas, dialysis, the morgue, pediatric locations, nursing homes, etc.
2. PCE data collected from each area/unit must be analyzed separately so that specific recommendations for each may be generated.

2. Evaluate the workplace environment:
  - Review the design of the physical work environment and identify ways to reduce risk, remove barriers, minimize travel, etc.
3. Evaluate other factors that may influence ergonomic risk:
  - Consider other factors that affect work performance, such as lighting, noise, equipment storage, and maintenance issues, and determine how to address their ergonomic risks.
4. Implement changes in the workplace.

### **The Patient Care Ergonomics Evaluation Process**

The PCE evaluation has three phases: (1) before, (2) during, and (3) after the unit ergonomic site visit.

#### **Before the Ergonomic Site Visit**

Collect data that will be used to give a snapshot of the ergonomic issues of each unit/area, confirm information gathered during the site visit, and make recommendations to decrease ergonomic risk. Begin gathering this information at least one month prior to the site visit and submit information at least one week before the site visit/walk-through takes place.

Develop lists of the following information before the site visit:

- High-risk tasks performed on the unit. High-risk tasks can be determined by
  - Surveying staff for their perceptions of the unit's high-risk tasks (See Tool 1: Perception of High-Risk Task Survey in Appendix H.)
  - Analyzing unit injury data (See Tool 2: Unit/Area Incident/Injury Profile in Appendix H.)
- Unit/area characteristics/issues relevant to ergonomic risk and actions to reduce it (See Appendix H: Clinical Unit/Area Characteristics and Ergonomic Issues Survey.)
  - Space
  - Storage
  - Equipment maintenance/repair
  - Patient population characteristics
  - Staffing characteristics
  - Equipment inventory

### During the Ergonomic Site Visit

The following activities take place:

- Interview staff to confirm data collected prior to the site visit and discover staff attitudes, concerns, ideas, information. (See Appendix F: Patient Care Ergonomic Evaluation, Staff Interview Template.)
- Observe the physical characteristics of the unit/area.
  - Equipment
    - Availability
    - Accessibility
    - Use
    - Storage location(s) and capacity
    - Condition
    - Structural issues that affect use
  - Patient room and toilet room
    - Sizes/configurations
    - Ceiling characteristics
    - Location of AC vents/TVs/sprinklers
  - Showering/bathing facilities
  - Safety design issues (e.g., thresholds, doorways)
- Note the way tasks are performed.
  - Showering/bathing process
  - Toileting process

- Document the results of interviews and observations. (See Appendix F: Patient Care Ergonomic Evaluation, Staff Interview Template.)

- Existing/ordered patient handling equipment
- Occurrence of high-risk tasks
- % total dependent and extensive assistance patients, % partial assistance patients
- Occurrence of bariatric/obese patients
- Room configurations
- Number of beds on the unit and average daily census
- Storage issues
- Other pertinent information
- Equipment/sling recommendations

### After the Ergonomic Site Visit

Analyze information collected during the previous two phases, and use the results to generate equipment recommendations. For a comprehensive PCE evaluation, prepare a report that covers the following categories, if appropriate for the unit/area:

- Patient handling equipment and sling recommendations
  - Storage recommendations
  - Recommendations to alter design features that impact patient handling and movement
  - Repair/maintenance process recommendations
  - Recommendations for facilitating injury reporting and the capture and analysis of injury data
  - Suggestions for improving the facility patient handling and movement program (PHAMP)
- Methods for improving the facility bariatric program

# APPENDIX F

## Patient Care Ergonomic Evaluation Staff Interview Template

Unit/Description:		Facility:	Date:
<b>Patient Care Ergonomic Issues</b>	<b>Existing/Ordered Unit Equipment</b>	<b>Patient Handling Equipment/Sling Recommendations</b>	
Vertical transfers/lifts (dependent/extensive-assistance patients)			
Vertical transfers/lifts (partial-assistance patients)			
Ambulation training			
Transportation			
Lateral transfers			
Repositioning side to side			
Pulling up to head of bed			
Repositioning in chair			
Wound care			
Ted hose application			
Toileting			
Showering/bathing			
# beds: _____ Average census: _____ % bariatric: _____ % total dependent/extensive assistance: _____ % total partial assistance: _____			
Room configurations: _____ Storage: _____			
Notes: _____			

# APPENDIX G

## Equipment Evaluation and Selection Process

The first stage in the evaluation and selection process for patient handling and movement (PHAM) equipment is to review and screen potential products for the desired purpose. Review product information from the manufacturer for each product under consideration, and then contact those manufacturers of interest to ask whether they have or know of information on prior or current clinical or lab evaluations. If the product manufacturer performed the evaluation, look at the findings carefully, as they may be biased. A literature search may unearth more information related to each product and company of interest. Limiting the number of competitive products to three to five will make it easier to do a thorough search.

Bring purchasing in early in the process to assist in the above tasks as well as with performance or cost of operation measures related to the equipment or the vendor.

Performance measures considered by purchasing staff include the following:

- Special features of the product not offered by comparable products
- Trade-in considerations
- Probable life of the product compared to similar products
- Warranty considerations
- Maintenance requirements and availability
- Past performance
- Environmental and energy-efficiency considerations

After representative equipment and vendors have been selected, it is important to give front-line staff an opportunity to try out the equipment. Therefore, the second stage of the equipment evaluation and selection process is to give front-line staff an opportunity to actually use and evaluate the equipment. Equipment clinical trials and equipment fairs can provide information to help compare the safety and usability of products and determine equipment appropriateness for

**Note:** Much of the information contained in this appendix either reflects lessons learned from VHA experience in conducting equipment evaluations or is taken from Ergonomics Technical Advisory Group, *Patient Care Ergonomics Resource Guide: Safe Patient Handling and Movement*, A. Nelson, ed. (Tampa: Veterans Administration Patient Safety Center of Inquiry, 2001), available at [www.visn8.va.gov/PatientSafetyCenter/safePtHandling](http://www.visn8.va.gov/PatientSafetyCenter/safePtHandling).

specific patient populations, ease of maintenance and repair, and the cost-benefit of purchasing such equipment.

Clinical trials test equipment in a clinical unit or area. The product is installed or loaned to the area/unit for a period of time. During this time, staff members are trained on the equipment, then use it with patients/residents. After a period of use, staff and patients or residents offer their thoughts on the equipment verbally or through specially designed product-rating surveys. (Sample surveys can be found on pages 6–7 of this appendix.)

An equipment fair may be an all-day event held on site in a large hall/auditorium so that many vendors may display their products, or it may be a smaller event focusing on one category of patient handling equipment. For each event, as many nursing staff as possible should come to try out the equipment under scrutiny. Housekeeping, maintenance, and other staff whose work may be impacted by the equipment should also be invited to evaluate it. As with the clinical trials, staff should be asked to offer their thoughts after using the equipment, usually on product rating surveys developed or modified to suit a particular facility's needs. If purchase is for long-term care facilities, physically and cognitively alert residents may also be asked to rate equipment and complete a survey. (See examples on pages 94–95.)

## Criteria for Selection of Lifting and Transferring Devices

Equipment chosen should have the following characteristics:

- It is appropriate for the task to be accomplished.
- It is safe for both the patient and the caregiver. The device must be stable and strong enough to secure and hold the patient. Use of the device should not subject caregivers to excessively awkward postures or high exertion of forces when gripping or operating equipment.
- Use of the equipment is comfortable for the patient. It should not produce or intensify pain, contribute to bruising of the skin, or tear the skin.
- The equipment can be managed with relative ease. In addition, instructions for its use should be relatively easy to understand.
- Its use is efficient time-wise.
- The equipment requires minimal maintenance.
- It has reasonable storage requirements.
- It can be maneuvered in a confined work-space.
- It is versatile.
- It is easy to clean and comply with infection control requirements.
- It is purchased in adequate numbers so that accessibility is not an issue.
- It is affordable.

Adapted from A. Nelson, ed., *Patient Care Ergonomics Resource Guide: Safe Patient Handling and Movement*, Chapter 12 (Tampa: Veterans Administration Patient Safety Center of Inquiry, 2001).

## Equipment Fair Lessons Learned

To ensure an equipment fair conducted as part of its effort was successful, the VHA Safe Patient Handling and Movement Research Project engaged many individuals in a collective effort. Preplanning and coordination of multiple facilities, vendors, and staff members were required to orchestrate the event. Following is an outline of the steps the VHA took to prepare for and conduct the fair:

- 1. Select equipment and participating vendors.**
  - a. A panel of experts in the field of safe patient handling and movement selected equipment for inclusion based on a literature review and their familiarity with the product.

Vendors selected were required to bring only the requested product(s).

- b. Approximately 15 pieces of equipment were selected for the equipment fair. Vendors were contacted individually, told what items to present, and given a point of contact for each facility. No participation fees were solicited from the vendors, but travel costs were borne by the vendor.

## 2. Coordinate site logistics.

- a. The event was held at seven sites within a two-week period. Dates were chosen to accommodate individual facility needs and given to the vendors. All vendors chose to participate.
- b. One individual in each facility was selected to coordinate the logistics for the fair at that location, including communication with vendors about their setup needs, arrangements for space, safety issues, and promotion of the event.

## 3. Promote the event.

- a. Various modes of communication were employed to promote the event, including e-mail, promotional posters, discussion at nurse staff meetings, and education of key personnel.
- b. Key personnel contacted included nurse managers, safety personnel, occupational health staff, nurse educators, union representatives, back injury resource nurses, engineering staff, and administrators.
- c. The event was promoted to all staff and emphasized in high-risk patient care units. (A high-risk unit is defined as an inpatient hospital unit with a high proportion of dependent patients with frequent moves in and out of bed. It includes long-term nursing and spinal cord care units.)
- d. In an effort to entice participation, compensation time was offered to high-risk nursing staff who did not work during event hours. Nurse managers were encouraged to offer nursing staff time away from the unit to participate.
- e. In most facilities, one hour of patient safety training was awarded to participants. Education sign-in sheets were made available at the site.

#### 4. Conduct the event on the designated day.

- a. Most of the sites held the event between the hours of 7 a.m. and 4 p.m. This afforded all three nursing shifts the opportunity to participate.
- b. VHA police were notified of the activity in advance. Vendor setup time was prearranged with the site coordinator and averaged 1.5 hours. Five of the facilities held the event in a large auditorium; the other two used vacant patient rooms.
- c. The facility site coordinator or a designee was responsible for coordinating events throughout the day.
- d. A member of the research project's core team was present to facilitate the evaluation process and to ensure the vendors did not distract VHA staff members from completing the evaluation process.

#### 5. Conduct the equipment survey during the fair.

- a. Participants were asked to fill out an equipment rating survey for each piece of equipment. The survey sought to identify the equipment preferences and needs of the specific facility through a rating system based on five questions related to patient care. (See forms on pages 92–95.)
- b. All facility staff members were allowed to complete the survey.
- c. High-risk unit nursing staff members were directed to complete a color-coded survey packet and to place it in a designated area.

#### 6. Collate and analyze the survey results.

- a. Equipment rating surveys were forwarded to staff for analysis.
- b. Equipment purchasing decisions were to be based on the survey data, specific facility needs identified through on-site ergonomic analysis, and cost considerations.

### Equipment Rating Surveys

At the end of this appendix are two sample equipment evaluation questionnaires—one for staff members and one for patients or residents of the facility. Instructions for staff members who have been assigned the responsibility for

making sure the surveys are distributed, filled out, and collected follow.

#### **Site Coordinator Instructions**

A simple questionnaire has been prepared to assist in decision-making with respect to safe patient handling technologies for our facility. Please express to nurse managers/supervisors and staff how important their cooperation is in completing these questionnaires. Purchasing decisions for our facility will be greatly influenced by staff preferences. Therefore, the more staff members who participate in the equipment fair and complete these questionnaires, the more reliable the decisions will be.

Please ensure there are enough copies of the evaluation form so that all staff can evaluate each piece of equipment, probably [insert your number] products in all. Completed forms should be handed back to the **site coordinator or designee before** staff members leave the equipment demonstration hall.

Evaluation forms must be collated by **clinical unit/area**.

You will probably be asked about the outcome of the survey. Inform staff how the survey will be analyzed and that cost factors will also help determine equipment selection.

#### **Clinical Unit/Area Nurse Manager/Supervisor Instructions**

The Safe Patient Handling Equipment Day will be here soon. In preparation for this, we have developed a simple questionnaire to assist in decision-making with respect to safe patient handling technologies for our facility. (Please review, discuss with staff, and post so they will be aware of what they will be asked to comment on.)

Please express to your staff how important their cooperation is in completing these questionnaires. Purchasing decisions for our facility will be greatly influenced by staff preferences. Therefore, the more staff members who participate in the equipment day and complete these questionnaires, the more reliable the decisions will be.

Completed forms should be handed back to the Safe Patient Handling and Movement Project site coordinator or designee **before** staff members leave the equipment hall.

**Product Feature Rating Survey (Caregiver)—Individual Product Form**

Caregiver #: \_\_\_\_\_ Product #: \_\_\_\_\_ Date: \_\_\_\_\_

Please examine the product very carefully and answer the following questions as they relate to this product ONLY. Answer each question using a scale from 0 to 10 by circling the number that matches your impression, where 0 indicates a very poor design and 10 indicates a very well-designed feature.

We encourage you to express any ideas you may have for improving the product design. Please make your comments alongside the appropriate feature rating.

**How would you rate your OVERALL COMFORT while using this product?**

0	1	2	3	4	5	6	7	8	9	10
Very Poor	Average							Very Good		

**What is your impression of this product's OVERALL EASE OF USE?**

0	1	2	3	4	5	6	7	8	9	10
Very Poor	Average							Very Good		

**How EFFECTIVE do you think this product will be in reducing INJURIES?**

0	1	2	3	4	5	6	7	8	9	10
Very Poor	Average							Very Good		

**How EFFICIENT do you feel this product will be in use of your TIME?**

0	1	2	3	4	5	6	7	8	9	10
Very Poor	Average							Very Good		

**How SAFE do you feel this product would be for the PATIENT?**

0	1	2	3	4	5	6	7	8	9	10
Very Poor	Average							Very Good		



## Product Feature Rating Survey (Caregiver)—Comparison Form

Caregiver #: \_\_\_\_\_ Date: \_\_\_\_\_

Please look at each of the products you have just used. Rank each of these products in order of preference. Place the letter assigned to each product (A–E) alongside the rank order you feel is most appropriate, where 1 is your most preferred design and 5 is your least preferred design. Note any comments you may have in the space provided. [Note: This form can be revised if more or fewer than five products are being evaluated.]

**Overall comfort:** 1: \_\_\_\_\_ 2: \_\_\_\_\_ 3: \_\_\_\_\_ 4: \_\_\_\_\_ 5: \_\_\_\_\_

Comments: \_\_\_\_\_  
 \_\_\_\_\_  
 \_\_\_\_\_

**Ease of use:** 1: \_\_\_\_\_ 2: \_\_\_\_\_ 3: \_\_\_\_\_ 4: \_\_\_\_\_ 5: \_\_\_\_\_

Comments: \_\_\_\_\_  
 \_\_\_\_\_  
 \_\_\_\_\_

**Stability:** 1: \_\_\_\_\_ 2: \_\_\_\_\_ 3: \_\_\_\_\_ 4: \_\_\_\_\_ 5: \_\_\_\_\_

Comments: \_\_\_\_\_  
 \_\_\_\_\_  
 \_\_\_\_\_

**Durability:** 1: \_\_\_\_\_ 2: \_\_\_\_\_ 3: \_\_\_\_\_ 4: \_\_\_\_\_ 5: \_\_\_\_\_

Comments: \_\_\_\_\_  
 \_\_\_\_\_  
 \_\_\_\_\_

**Versatility:** 1: \_\_\_\_\_ 2: \_\_\_\_\_ 3: \_\_\_\_\_ 4: \_\_\_\_\_ 5: \_\_\_\_\_

Comments: \_\_\_\_\_  
 \_\_\_\_\_  
 \_\_\_\_\_

**Product Feature Rating Survey (Patient)—Individual Product Form**

Patient #: \_\_\_\_\_ Product #: \_\_\_\_\_ Date: \_\_\_\_\_

This questionnaire examines ONLY the product you have just used. Please rate each of the following design features on a scale from 0 to 10 by placing a mark along the line, where 0 indicates a very poor design and 10 indicates a very well-designed feature.

We would appreciate hearing any ideas you may have for improving the product design. Please make your comments beside the appropriate feature rating or on the overleaf if you need more space.

**Overall comfort**

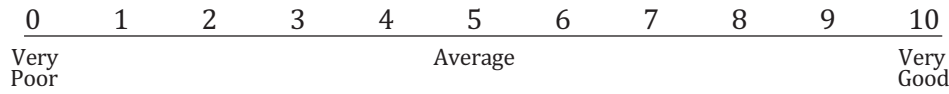

**Security**

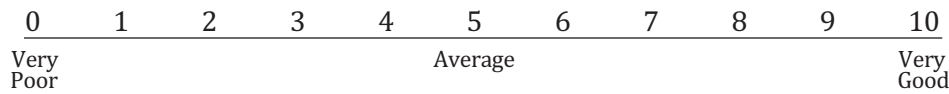

**Safety**

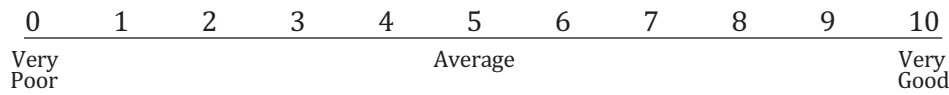

**Other relevant feature**

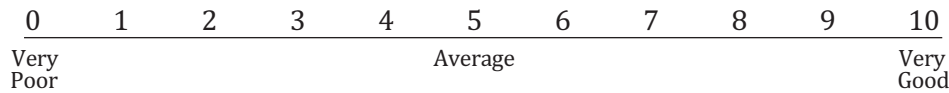

**Other relevant feature**

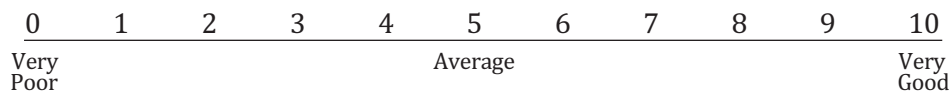

## **Product Ranking Survey (Patient)—Product Comparison Form**

Patient #: \_\_\_\_\_ Date: \_\_\_\_\_

Please look at each of the products you have just used. Rank each of these products in order of preference. Place the letter assigned to each product (A–E) alongside the rank order you feel is most appropriate, where 1 is your most preferred design and 5 is your least preferred design. Note any comments you may have in the space provided.

**Overall comfort:** 1: \_\_\_\_\_ 2: \_\_\_\_\_ 3: \_\_\_\_\_ 4: \_\_\_\_\_ 5: \_\_\_\_\_

Comments: \_\_\_\_\_  
 \_\_\_\_\_  
 \_\_\_\_\_

**Security:** 1: \_\_\_\_\_ 2: \_\_\_\_\_ 3: \_\_\_\_\_ 4: \_\_\_\_\_ 5: \_\_\_\_\_

Comments: \_\_\_\_\_  
 \_\_\_\_\_  
 \_\_\_\_\_

**Safety:** 1: \_\_\_\_\_ 2: \_\_\_\_\_ 3: \_\_\_\_\_ 4: \_\_\_\_\_ 5: \_\_\_\_\_

Comments: \_\_\_\_\_  
 \_\_\_\_\_  
 \_\_\_\_\_

**Other relevant feature:** 1: \_\_\_\_\_ 2: \_\_\_\_\_ 3: \_\_\_\_\_ 4: \_\_\_\_\_ 5: \_\_\_\_\_

Comments: \_\_\_\_\_  
 \_\_\_\_\_  
 \_\_\_\_\_

**Other relevant feature:** 1: \_\_\_\_\_ 2: \_\_\_\_\_ 3: \_\_\_\_\_ 4: \_\_\_\_\_ 5: \_\_\_\_\_

Comments: \_\_\_\_\_  
 \_\_\_\_\_  
 \_\_\_\_\_

# APPENDIX H

## Clinical Unit/Area Characteristics and Ergonomic Issues Survey

Type of Unit/Area: \_\_\_\_\_ Facility: \_\_\_\_\_

### PART 1—SPACE/MAINTENANCE/STORAGE

- a. Describe unit, including number of beds, room configurations (private, semi-private, 4-bed, etc.), and toilet rooms:

# rooms w/ 2 beds: \_\_\_\_\_ w/ 3 beds: \_\_\_\_\_ w/ 4 beds: \_\_\_\_\_ private: \_\_\_\_\_

Toilet rooms: In room? \_\_\_ Community? \_\_\_ Use tub? \_\_\_ Bathing chair? \_\_\_ Other? \_\_\_

- b. Describe current storage conditions and problems you have with storage. If new equipment were purchased, where would it be stored?
- c. Identify anticipated changes in the physical layout of your unit, such as planned unit renovations in next two years.
- d. Describe space constraints for patient care tasks and use of portable equipment; focus on patient rooms, toilet rooms, shower/bathing areas. *Are typical room doorways narrow or wide? Is the threshold uneven?*
- e. Describe any routine equipment maintenance program or process for fixing broken equipment. What is the reporting mechanism/procedure for identifying, marking, and getting broken equipment to shop for repair? *Is equipment on a PM schedule?*
- f. If the potential for installation of overhead lifting equipment exists, describe any structural factors that may influence this installation, such as structural load limits, lighting fixtures, AC vents, the presence of asbestos, etc.

## **PART 2—STAFFING**

- a. Peak lift load times (Think about the time of day that's the busiest. What is the number of staff that would be lifting at same time?):
  
- b. Discuss projected plans or upcoming changes in staffing, patient population, or bed closures in the next two years.

## **PART 3—PATIENTS/RESIDENTS**

- a. Describe the average patients/residents on your unit (hospice, Alzheimer, TBI, etc.) and variability in this.
  
- b. Discuss proposed changes in the average daily census over the next two years.
  
- c. Identify typical distribution (%) of patients by physical dependency level according to the definitions below. **(Base on physical limitations, not on clinical acuity.)**

**Table H-1: Physical Dependency Levels of Patient Population\***

_____	<b>Total dependence:</b> Cannot help at all with transfers, full staff assistance for activity during entire seven-day period. Requires total transfer at all times.
_____	<b>Extensive assistance:</b> Can perform part of activity, usually can follow simple directions, may require tactile cueing, can bear some weight, sit up with assistance, has some upper body strength, or may be able to pivot transfer. Over the last seven-day period, help provided three or more times for weight-bearing transfers or may have required a total transfer.
_____	<b>Limited assistance:</b> Highly involved in activity, able to pivot transfer, and has considerable upper body strength and bears some weight on legs. Can sit up well, but may need some assistance. Guided maneuvering of limbs or other non-weight-bearing assistance three or more times, or help provided one or two times during the last seven days.
_____	<b>Supervision:</b> Oversight, encouragement, or cueing provided three or more times during the last seven days or physical assistance provided only one or two times during the last seven days.
_____	<b>Independent:</b> Can ambulate normally without assistance, but in unusual situations may need some limited assistance. Help or oversight may have been provided only one or two times in the last seven days.

\*This table is excerpted from *Patient Care Ergonomics Resource Guide: Safe Patient Handling and Movement* ([www.vsn8.va.gov/PatientSafetyCenter/safePtHandling](http://www.vsn8.va.gov/PatientSafetyCenter/safePtHandling)).

- d. Have *all* staff complete (collated by unit and shift) Tool 1: Perception of High-Risk Task Survey.

## **PART 4—PATIENT HANDLING INJURIES**

Have each unit complete Tool 2: Unit/Area Incident/Injury Profile.

## **PART 5—EQUIPMENT**

- a. Use Tool 3: Unit Patient Handling Equipment Inventory to provide an inventory of all patient care equipment. This should include a description of the working condition of each piece of equipment and how frequently it is used.
  
- b. What percentage of high-risk tasks is completed using proper equipment? Why?
  
- c. Identify your problem areas.
  
- d. What equipment do you think you need?

Person completing report:

---

Name	Date
Title	Phone #

(This survey form is a revision of Figure 3-3: Pre-Site Visit Unit Profile in A. Nelson, ed., *Patient Care Ergonomics Resource Guide: Safe Patient Handling and Movement* Chapter 4, p. 24 (Tampa: Veterans Administration Patient Safety Center of Inquiry, 2001). Available at [www.visn8.va.gov/PatientSafetyCenter/safePtHandling](http://www.visn8.va.gov/PatientSafetyCenter/safePtHandling).)

## Tool 1: Perception of High-Risk Tasks Survey

Directions: Assign a rank (from 1 to 10) to the tasks you consider to be the highest risk tasks contributing to musculoskeletal injuries for persons providing direct patient care. (A 10 should represent the highest risk and a 1 the lowest.) Consider the frequency of the task (high, moderate, low) and the musculoskeletal stress (high, moderate, low) when assigning a rank. Delete tasks not typically performed on your unit. You can have each nursing staff member complete the form and summarize the data, or you can have staff work together by shift to develop the rank by consensus.

Patient Handling Tasks	Task Frequency	Stress of Task	Rank
	<i>H = high</i> <i>M = moderate</i> <i>L = low</i>	<i>H = high</i> <i>M = moderate</i> <i>L = low</i>	<i>10 = highest risk</i> <i>1 = lowest risk</i>
Transferring patient from bathtub to chair			
Transferring patient from wheelchair or shower/commode chair to bed			
Transferring patient from wheelchair to toilet			
Transferring patient from bed to stretcher			
Lifting patient up from the floor			
Weighing patient			
Bathing patient in bed			
Bathing patient in a shower chair			
Bathing patient on a shower trolley or stretcher			
Undressing/dressing patient			
Applying anti-embolism stockings			
Lifting patient to the head of the bed			
Repositioning patient in bed from side to side			
Repositioning patient in geriatric chair or wheelchair			
Making occupied bed			
Feeding bedridden patient			
Changing absorbent pad			
Transporting patient off unit			
Other task:			

Adapted from B. D. Owen & A. Garg, *AAOHN Journal* 39, no. 1 (1991).

**Tool 2: Unit/Area Incident/Injury Profile**

Facility: \_\_\_\_\_ Unit: \_\_\_\_\_

Dates included: \_\_\_\_\_ Date completed: \_\_\_\_\_

Patient Care Activity (Reposition, bathe, transfer, etc.)	Cause of Injury (Pull, push, reach, struck, etc.)	Type of Injury (Strain/sprain, contusion, struck, etc.)	Body Part(s) (Upper/mid/lower back, legs, neck, etc.)	Location (Patient room, hall, sunroom, etc.)	Lost Time (# days)	Modified Duty (# days)
<b>Example:</b> Repositioning (side to side)	Reaching, pulling residents all night—shoulder hurts	S/S	Shoulder	Patient room	No	4 days

#1 Activity: \_\_\_\_\_ #1 Cause: \_\_\_\_\_ Modified duty trend? \_\_\_\_\_

#2 Activity: \_\_\_\_\_ #2 Cause: \_\_\_\_\_ Lost time trend? \_\_\_\_\_



**Tool 3: Unit Patient Care Equipment Inventory**

Unit: \_\_\_\_\_ Facility: \_\_\_\_\_ Date completed: \_\_\_\_\_

<b>Patient Care Equipment</b>	<b>Manufacturer/ Style/Name</b> (e.g., Arjo Maxi Move)	<b>Inventory</b> (Total # in unit now)	<b># in Working Order</b>	<b>% Being Used Now</b> (Comment)	<b># Requested</b>
<b>FULL-BODY SLING LIFTS</b>					
Floor-based, <i>powered</i> lifts (e.g., Arjo Maxi Move)					
Floor-based, <i>non-powered</i> lifts (e.g., Hoyer)					
<i>Ceiling-mounted</i> lifts (e.g., BHM Voyager)					
<i>Bathing</i> lifts					
<b>LATERAL TRANSFER AIDS</b>					
<i>Mechanical</i> lateral transfer aids (e.g., Mobilizer, Totalift II, On-3)					
<i>Friction-reducing</i> lateral sliding aids (e.g., Sliding/Surf Boards, RTA, Phili slide)					
<i>Air-assisted</i> lateral transfer aids (e.g., AirPal, Hovermat)					
<b>OTHER EQUIPMENT</b>					
Transfer chairs (e.g., Transitchair)					
Dependency chairs (e.g., Broad, Geri-Chair)					
Powered standing assist and repositioning lifts (e.g., Translift, Raisa Lift)					
Standing assist and repositioning aids (non-powered) (e.g., Super/Pivot Pole, Bed-Bar)					
Gait belts (with handles)					
Other					

# APPENDIX I

## Ceiling Lift Coverage Recommendations by Clinical Unit/Area

Determining ceiling lift coverage for clinical units/areas can be accomplished by using Table I-1 and/or by calculation (see second head below).

### Determining Ceiling Lift Coverage Using the Table

Table I-1 can be used to make ceiling lift coverage recommendations that stipulate the percentage of patients who should be covered on a particular unit or area. Remember, insufficient coverage will result in increases in the risk of staff and patient injury.

### Calculating Ceiling Lift Coverage

(Use only for units/areas assigned ranges of coverage in Table I-1.)

Because the patient characteristics of clinical units/areas vary widely, it is critical to base ceiling lift purchase decisions on these characteristics. Unit ceiling lift coverage is based on the type of unit/area; the dependency levels of the patient/resident population; and the number of private, semi-private, three-bed, or four-bed rooms on the unit.

**Note:** Patient dependency level is based on physical limitations and dependency. It is not the same as clinical acuity or patient acuity.

**Step 1:** Determine the average percentage of patients requiring ceiling lift system coverage.

Add the average percentage of totally dependent patients on the unit to the average percentage of patients needing extensive assistance. (Use Table H-1: Physical Dependency Levels of Patient Population in Appendix H to determine the numbers of patients at each dependency level on the unit; the total for the five categories should equal 100 percent.)

Average % totally dependent patients on unit  
+ Average % extensive assistance patients on unit  
Average % patients requiring ceiling lift coverage

**Step 2:** Determine the number and configuration of rooms requiring ceiling lift systems per unit.

Use the average percentage of patients requiring ceiling lift coverage to calculate the number of rooms needing ceiling lifts:

*For units w/ only private patient rooms:*

Number of patients  
 $\times$  Average % patients requiring ceiling lifts  
Number of private patient rooms with ceiling lifts

*For units with only semi-private rooms:*

Number of patients divided by 2  
 $\times$  Average % patients requiring ceiling lifts  
Number of semi-private patient rooms with ceiling lifts

*For units with a mix of room configurations:*

For cost-effectiveness in existing construction, and if appropriate for the unit, begin calculations with ceiling lifts placed in most or all larger wards (three- and four-bed wards), then as appropriate in smaller rooms (private and semi-private).

**Example:** This sample calculation is for a medical/surgical unit that accommodates 30 patients and has four private rooms, 10 semi-private rooms, and two three-bed rooms. Approximately 70 percent of the patients on the unit will require the use of ceiling lifts. Therefore, the unit should have coverage for 21 patients (70 percent  $\times$  30 patients). For cost-effectiveness, and if appropriate for unit needs, ceiling lift coverage may be as follows: ceiling lifts in two three-bed rooms (covering 6 patients), seven semi-private rooms (covering 14 patients), and one private room (covering one patient) in order to have ceiling lift coverage for 21, or 70 percent, of the patients.

**Table I-1: Ceiling Lift Coverage Recommendations by Clinical Unit/Area**  
(Based on Veterans Health Administration patient populations)

CLINICAL UNIT/AREA	CEILING LIFT PATIENT/BED COVERAGE	PREFERRED TRACK CONFIGURATION
Medical/surgical unit	50–100%*	Traverse
Post-surgical unit <i>Provide one supine sling and hanger bar system for unit.</i>	50–100%*	Traverse
Rehab unit <i>Consider installing straight track down hallway for ambulating patients.</i>  <i>Provide one supine sling and hanger bar system for unit.</i>	50–100%* <i>(If unit is primarily neuro rehab, provide a minimum of 70% coverage.)</i>  <i>(For new construction or rooms large enough for ambulation within rooms, provide 100% coverage to assist in gait training, etc.)</i>	Traverse
MICU	100%	Traverse
SICU	100%	Traverse
CCU	50%	Traverse or straight
ICU <i>(Combined MICU/SICU/CCU)</i>	100%	Traverse
Nursing home/long-term care	70–100%* <i>(Less coverage may be provided for primarily dementia units.)</i>	Traverse <i>(Into bathroom)</i>
Hemodialysis <i>(Ceiling lift coverage is needed over areas where lateral transfers from stretchers or inpatient beds to dialysis beds occur.)</i>	50–100%*	Straight or traverse <i>(One straight track over several bays in a row would be appropriate.)</i>
Radiology (X-ray, CT, etc.) <i>(Overhead/ceiling lift system must be compatible with ceiling-mounted radiological equipment.</i>  <i>Careful coordination is required to avoid conflicts between ceiling lift tracks and gantries in radiology rooms with traverse ceiling-mounted equipment.)</i>	50%	Traverse or straight
MRI	100%	Straight <i>(Located in adjacent MRI patient transfer area)</i>
Nuclear medicine	50%	
Procedure areas <i>(GI, cystoscopy, etc.)</i>	100%	100% <i>(Positioned as needed)</i>
Cath lab	100%	Traverse or straight
PACU	100%	Straight <i>(If possible, extended over all beds in a row using one lift system per row)</i>

CLINICAL UNIT/AREA	CEILING LIFT PATIENT/BED COVERAGE	PREFERRED TRACK CONFIGURATION
Operating room (Ceiling- or wall-mounted equipment in ORs requires careful coordination between lift tracks, traversing lift motors, and other equipment suspended from or mounted on ceilings and walls.)	100%	Traverse
Physical therapy clinics	100%	<i>Preferred design:</i> Traverse system covering the entire area possibly using two or more motors simultaneously (on the parallel bars and at any treatment tables)  <i>Alternate design:</i> Straight track installed over parallel bars, traverse track system covering treatment tables and activity areas
Spinal cord injury	100%	Traverse into bathroom
Outpatient SCI clinic exam/treatment rooms	100%	Traverse
Outpatient/primary care clinics	Depending on patient population, one or more regular and/or one expanded capacity/bariatric lift	Traverse
Emergency department Urgent care exam rooms <i>Provide one supine sling and hanger bar system for unit.</i>	50–100%*	<i>Preferred design:</i> Traverse over multiple bays in a row or in private rooms <i>Alternate design:</i> Straight track over several bays in a row or in private rooms
Ambulance bay	Depending on patient population, one regular or one expanded capacity/bariatric lift under canopy in ambulance bay	Traverse (Ensure proper coordination of ceiling lift track with entrance doorways.)
Dental	Depending on patient population, one regular and/or one expanded capacity/bariatric lift	Straight or traverse
Pediatrics	20%	Traverse
Morgue (Expanded capacity lift with minimum weight capacity of 600 lbs. or greater depending on patient population characteristics. Include supine lift frame in purchase.)	100%	Traverse or straight (Lift system should be able to assist in inserting and extracting trays into cooler as well as lifting and moving bodies into and within autopsy suite.)
Nurse training area	One	Straight

\*For those clinical units/areas with a range for required lifts (e.g., 30–100 percent), determine coverage using patient characteristics as instructed in the directions above the table.

# APPENDIX J

## Floor-Based Lifts Coverage Determination

To determine the number of floor-based lifts required for a unit or facility, the general rule of thumb is one portable lift per 8–10 patients. For example, the number of sit-to-stand lifts needed for a unit with 30 patients, 30 percent of whom are categorized as requiring partial assistance, (n=9) is one lift. The number of floor-based, full-body sling lifts required in a unit with no ceiling lifts in place and 30 patients, 60 percent of whom are considered fully dependent or require extensive assistance (n=18), is two lifts.

When deciding how much portable equipment to purchase, consider peak patient handling and movement times/loads during each shift. Note that the number of portable, floor-based lifts will be reduced with the introduction of fixed lift systems, such as ceiling-mounted systems.

Table J-1 can be used to determine the number of floor-based lifts—both full-body sling lifts and sit-to-stand lifts—needed for each clinical area/unit.

### ■ Floor-based sling lift recommendations.

These are based on ceiling lift coverage as specified and calculated using Table I-1 in Appendix I.

- If ceiling lift coverage is less than that in Table I-1, the need for floor-based sling lifts will increase, requiring more storage space. Use the rule of thumb of one per 8–10 dependent patients not covered by ceiling lifts (from the NIOSH article referenced in Table I-1).
- With full ceiling lift coverage as in Table I-1, floor-based sling lifts may be shared by units on one or more floors, decreasing the number required.

### ■ Sit-to-stand lift recommendations

- The recommendations shown in Table J-1 apply when there is no other means of risk control for the patient characteristics and activities being addressed (toileting, dressing, peri-care, vertical transfers, etc., of partially dependent patients).
- Now that ambulation slings with ceiling lifts are used more often to assist in ambulating and vertical transfers, the quantity of sit-to-stand lifts needed (and associated space requirements) will decrease when other ceiling lift adaptations or technology are used and/or available.

**Table J-1: Portable/Floor-Based Lift Minimal Coverage by Clinical Area/Unit**

CLINICAL UNIT/AREA	RECOMMENDED COVERAGE	
	Sit-to-Stand Lifts	Floor-Based Sling Lifts <sup>2</sup>
General medical unit	One per 8–10 partially weight-bearing patients <sup>1</sup>	One per floor or unit
Medical/surgical unit	One per 8–10 partially weight-bearing patients <sup>1</sup>	One per floor or unit
Post-surgical unit	One per 8–10 partially weight-bearing patients <sup>1</sup>	One per floor or unit
Rehab unit	One per 8–10 partially weight-bearing patients <sup>1</sup>	One per floor or unit
MICU	One per 8–10 partially weight-bearing patients <sup>1</sup>	One per floor or unit
SICU	One per 8–10 partially weight-bearing patients <sup>1</sup>	One per floor or unit
CCU	One per 8–10 partially weight-bearing patients <sup>1</sup>	One per floor or unit
ICU (Combined MICU/SICU/CCU)	One per 8–10 partially weight-bearing patients <sup>1</sup>	One per floor or unit
Nursing home/long term care	One per 8–10 partially weight-bearing patients <sup>1</sup>	One per floor or unit
Geri-psych	One per 8–10 partially weight-bearing patients <sup>1</sup>	One per floor or unit
Psychiatry	One per 8–10 partially weight-bearing patients <sup>1</sup>	One per floor or unit
Emergency dept./urgent care	One	One
Radiology/diagnostics (X-ray, CT, nuclear medicine, MRI) <i>(If possible, specify diagnostic tables without pedestals or with pedestal design that accommodates placement of portable/floor-based lifts under table and around pedestal.)</i>	One per entire radiology/diagnostic area <i>Note: Tables must accommodate lift bases.</i>	One per entire radiology/diagnostic area <i>Note: Tables must accommodate lift bases.</i>
Physical therapy clinics	One per clinic	One per clinic
OR	None	None
PACU	None	None
Procedure areas (GI, cystoscopy, cath lab, etc.)	One per floor/unit	One per floor or unit
Spinal cord injury unit	None or one <i>(Depending on patient population)</i>	One per floor or unit
Outpatient SCI clinic exam/treatment rooms	None or one <i>(Depending on patient population)</i>	None
Outpatient/primary care clinics <i>Exam tables must accommodate lift base.</i>	One <i>(May need additional lifts if clinics are not in close proximity to one another)</i>	One <i>(May need additional lifts if clinics are not in close proximity to one another)</i>

CLINICAL UNIT/AREA	RECOMMENDED COVERAGE	
	Sit-to-Stand Lifts	Floor-Based Sling Lifts <sup>2</sup>
Hemodialysis <i>Chair design must accommodate lift base.</i>	One <i>(Depending on typical patient population and whether using chairs and/or beds)</i>	None
Dental <i>Dental chairs must accommodate lift base.</i>	One	None
Pediatrics	One	One
Nurse training area	One	One
Morgue	None	If no ceiling lift, provide "morgue lift."

1 J. Collins et al., *Safe Lifting and Movement of Nursing Home Residents* (DHHS [NIOSH] Publication Number 2006-117, 2006).

2 These recommendations are based on ceiling lift coverage as shown in Table I-1 in Appendix I.

# APPENDIX K

## Design/Layout Considerations for Ceiling/Overhead Lift Tracks

At present, not all clinical units or areas require 100 percent ceiling lift coverage (Table I-1), but with expansion in ceiling lift and sling technology, this is expected to change. In the near future, full coverage may be warranted for most patient rooms. Therefore, some patient handling experts recommend installing tracks in every room during new construction or renovation to accommodate future installation of a ceiling lift system. Installing the track during construction (new or renovation) may decrease the ultimate cost for installation of a ceiling lift system.

The information in this appendix is intended to assist in selection of the best ceiling lift track design and installation options, and to ensure consideration is made for other decisions that impact ceiling lift design. These include ceiling lift

charging options, options for the physical movement of ceiling lifts, track design options, track design suggestions for various clinical areas, track support and fastening options, and other track design/layout options for consideration.

### Ceiling Lift Motor Charging Options

**Stationary charging system.** A charging/docking station is attached to the track, and for charging to take place, the lift must be brought to and docked at the charging station. Usually, the charging station is located away from traffic areas.

**Electronic (continuous) charging system (ECS).** The track contains copper stripping that enables charging of the lift motor throughout the

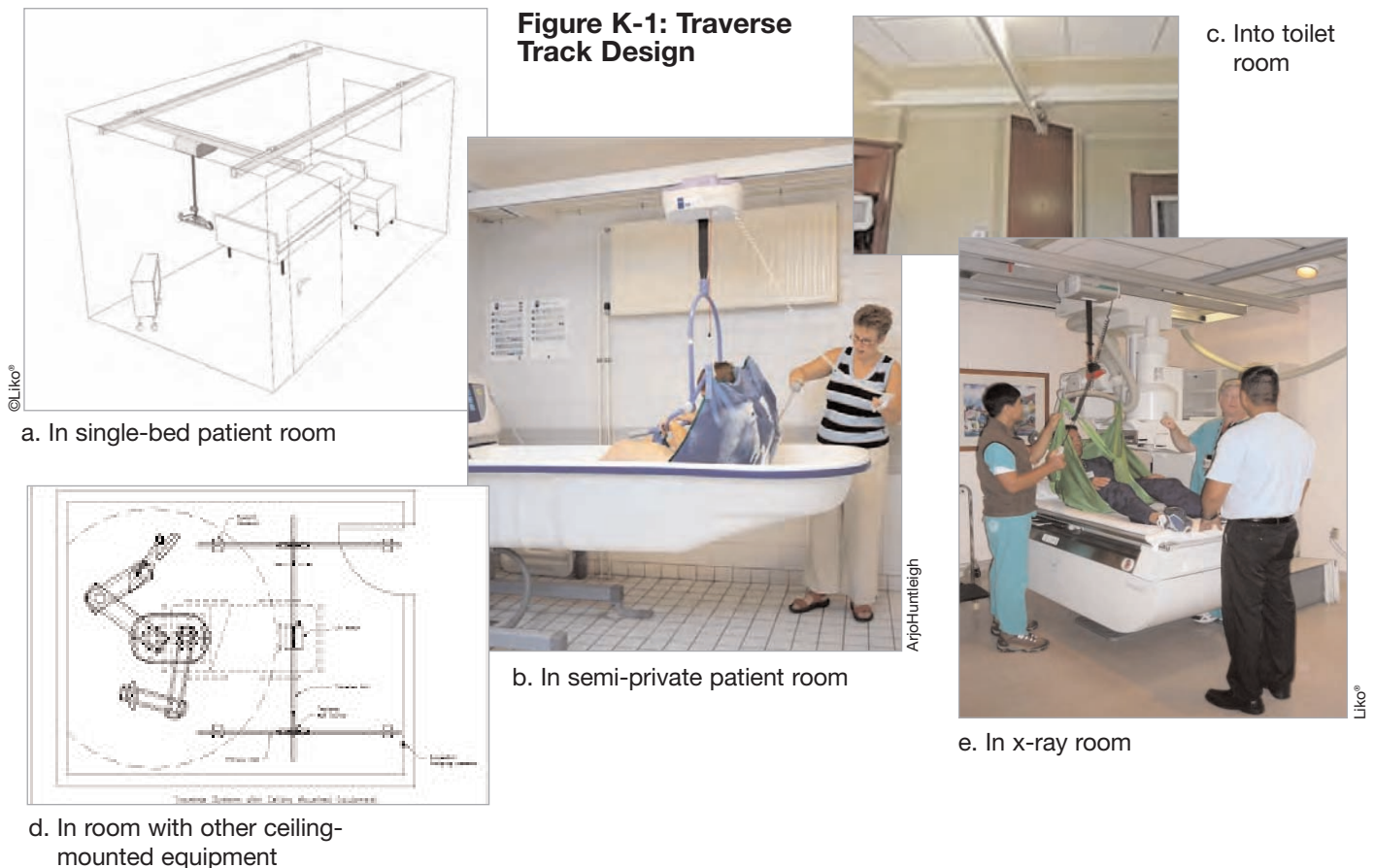



length of the track at all times. Continuous charging occurs along the entire length of the track not just in one specific location.

### Ceiling Lift Movement

All ceiling lifts enable a patient to be lifted up and lowered vertically. However, some lifts offer options for side to side, horizontal movement. A ceiling lift can be moved horizontally by the caregiver either manually using a non-motorized track or with a hand-held (remote) device using a motorized track.

**Non-motorized track.** Most caregivers prefer to pull the lift horizontally by hand rather than press a button and wait for the lift to move to the desired location. Movement is quite smooth and easy with this design. However, caregivers must pull the lift manually, although easily, to the recharging area if there is a charging/docking station. With an ECS, the lift can be charged at any location along the track.

**Motorized track.** A motorization component enables the caregiver to use a hand-held (remote) device to move the lift horizontally along the track as well as to move the patient up and down (vertically). If the lift has a charging/docking station

and is motorized, a “return-to-charge” function moves the lift to the charging/docking station after a patient has been moved or lifted. With an ECS, the lift can be charged at any location along the track.

### Track Design Options

Three track design options are commonly used.

**Traverse (room covering) track.** In most rooms, a traverse track (Figure K-1) gives staff more options for transfers and performance of patient handling activities. This design also offers the patient more opportunity for rehabilitation and more timely patient handling assistance. However, traverse track designs may affect the use of privacy curtains. When including a traverse track, room design specifications must incorporate solutions that ensure patient privacy. (See below for more information on privacy curtains/screens.)

**Straight track.** A straight track configuration (Figure K-2) is only recommended when a room is small and the straight track can reach all areas where patient handling and placement will occur (when the sink is in line with the bed, the chairs have easy access to the bed, etc.).

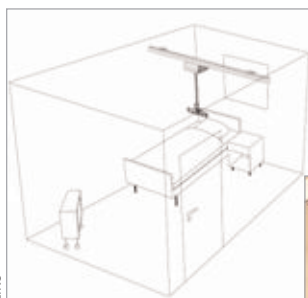

f. Over bed

**Figure K-2: Straight Track Design**

©RoMedic



i. In dialysis clinic



h. Over parallel bars in PT clinic



**Figure K-3: Curved Track Design**

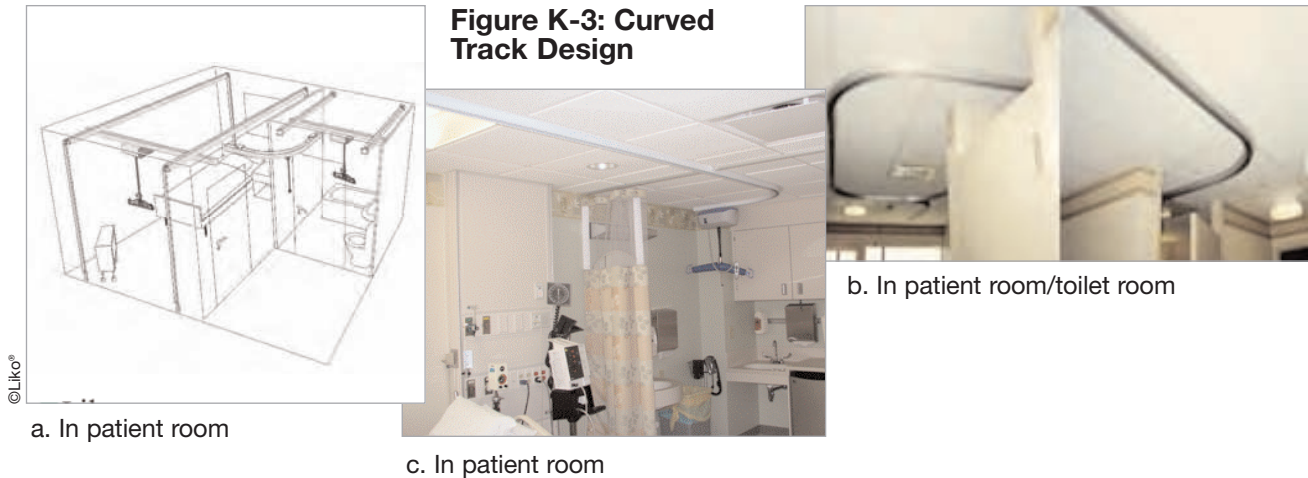

a. In patient room

b. In patient room/toilet room

c. In patient room

d. In intensive care unit

**Figure K-4: Integrated Track Design**



**Curved track.** Curved tracks (Figure K-3) are used for turns/transitions from one room into another; when ceiling obstructions such as lights, sprinklers, or other objects hang too low to accommodate a straight track; and to enhance the appearance of the lift system.

**Integrated track.** A fourth option is a track system integrated into a headwall or utility column (Figure K-4).

**Track Designs for Clinical Areas**

Following are track design recommendations for specific clinical areas. (Please note that track extension into the toilet room is highly recommended for all patient rooms. However, it is not universally included below as it is not always feasible.)

**Standard patient room**

- Preferred layout: Traverse track covering patient/resident room (Figure K-1)
- Alternate layout: Straight rail/track over patient bed (limits room coverage) (Figure K-2)

**Spinal cord injury (SCI) patient room**

- Traverse track covering patient room extending into toilet room (Figure K-5)

**CCU/ICU patient room**

- Preferred layout: Traverse track covering patient room (Figure K-1)
- Alternate layouts:
  - Straight rail/track over patient bed (Figure K-2)
  - Integrated track system (Figure K-4)

**Nursing home care unit (NHCU) patient room**

- Preferred layout: Traverse track covering patient room extending into toilet room (Figure K-5)
- Alternate layout: Traverse track covering patient room (Figure K-1)

**Bariatric patient room**

- Preferred layout: Traverse track covering patient room extending into toilet room (Figure K-5)
- Alternate layout: Traverse track covering patient room extending into toilet/shower

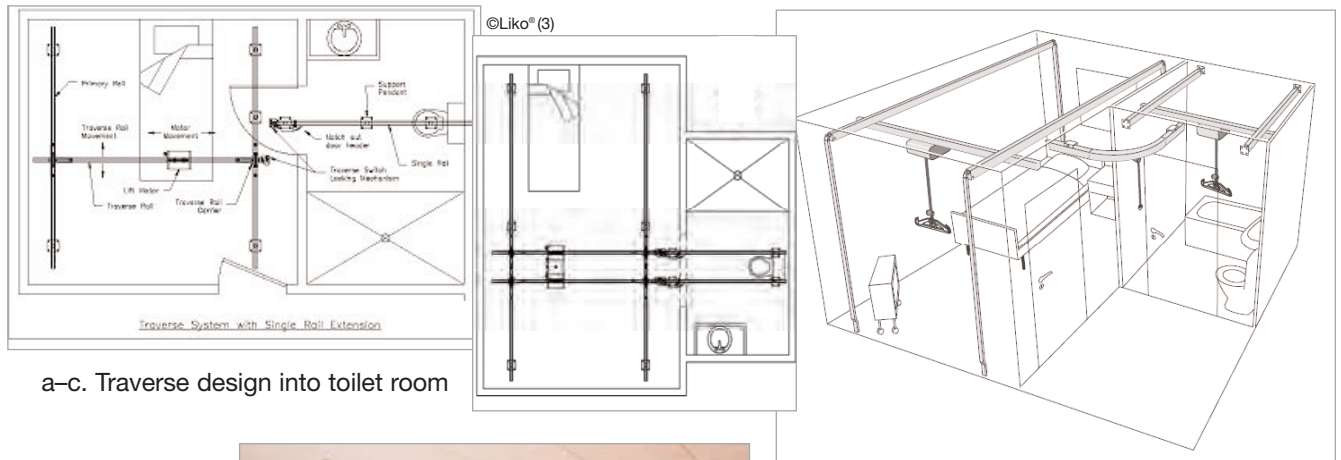

a-c. Traverse design into toilet room



d-e. Straight track design with curve into toilet room

K-5: Ceiling-Lift Tracks Extending from Patient Room into Toilet Room

Figure K-7: Suspended Track



©Liko® (2)

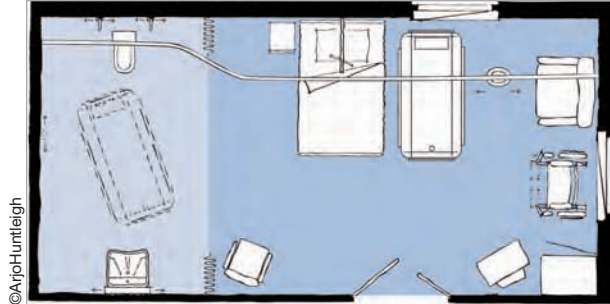

Figure K-6: Toilet Room Incorporated into Bariatric Patient Room

area with open room/toilet room design (Figure K-6)

**Alternate designs for clinical areas.** A few alternative track design options are suitable for SCI, bariatric, nursing home, and other patient rooms that require or allow coverage into toilet rooms.

- Ceiling lift tracks into toilet room through doorway (Figure K-4)
- Bariatric room design that incorporates the toilet/shower area into the bariatric patient room, using screens/privacy curtains rather than doors, making it easier to run track and transport bariatric patients from one area to the next (Figure K-6)

**Other Track Design Options**

Tracks may be suspended (Figure K-7) or recessed (Figure K-8). The recessed option is preferred, as this style diminishes the aesthetic impact in patient rooms; however, suspended tracks allow clearance for sprinkler heads, lights, curtain tracks, and other obstacles. When installing recessed tracks, ensure that the dropped ceiling grid is butted up against the track.

**Track Support/Fastening Options**

The structural capacity of the building element to which the lift is anchored must be capable of supporting the combined weight capacity of the lift, weight of the lifting equipment, and all other

©Liko®

DSGW Architects

©ArjoHuntleigh

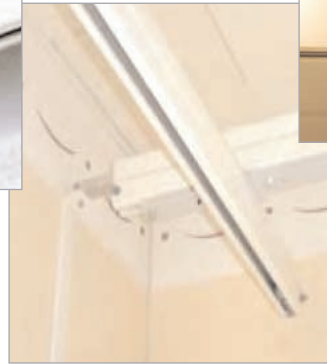

Figure K-8: Recessed Track



a. Bracket support

Figure K-9: Wall-Mounted Tracks



b. Upright support



c. Wall channel track

©Ergolet

©Liko®



Figure K-10: Pendant Attachment

©Liko® (2)



Figure K-11: Threaded Rod Mount

©Liko®

superimposed loads. Both static and dynamic loads must be considered. This capacity should be evaluated by a structural engineer.

Three types of attachment options are described here; others may be available. Consult with ceiling lift manufacturers for options specific for their tracks. Be aware that the interstitial space dictates the amount of lateral bracing required. In addition, the type of attachment method (rod or pendant) needed to achieve a stable system varies.

- **Wall mount:** Attached to wall with a wall bracket and/or uses an upright support. For a traverse track, suspended in a wall channel track. Economical, appropriate for renovations (Figures K-9).
- **Pendant:** Steel plate bolted to an engineered metal framing system and anchored to the supporting structure. Lateral support is normally used when interstitial space is greater than 19.5 in. See manufacturer’s specification and instructions. Tracks can be fully or partially recessed into the ceiling (Figure K-10).
- **Threaded rod:** Threaded rods can be mounted using an engineered metal framing

system attached to spanning beams or trusses. Tracks can be fully or partially recessed into the ceiling (Figure K-11).

**Other Ceiling and Wall-Mounted Track Design and Layout Considerations**

The following should be considered in determining track layout:

- **Items in ceiling:** Light fixtures, AC diffusers, fire sprinkler heads, televisions, X-ray equipment, OR lights, and other fixtures.
- **Items above ceiling:** Other ceiling-mounted equipment (e.g., radiology equipment), HVAC ducts, electrical conduits, plumbing, etc.
- **Wall-mounted barriers:** TVs, light fixtures, cabinets, and door swing radius.
- **Structural materials in building frame:** Building elements such as joists, beams, etc.
- **Building system elements:** Mechanical and electrical system features such as air ducts and electrical conduits.
- **Unique architecture:** Multi-level ceiling heights, vaulted ceilings, soffits, non-structural or radius walls.

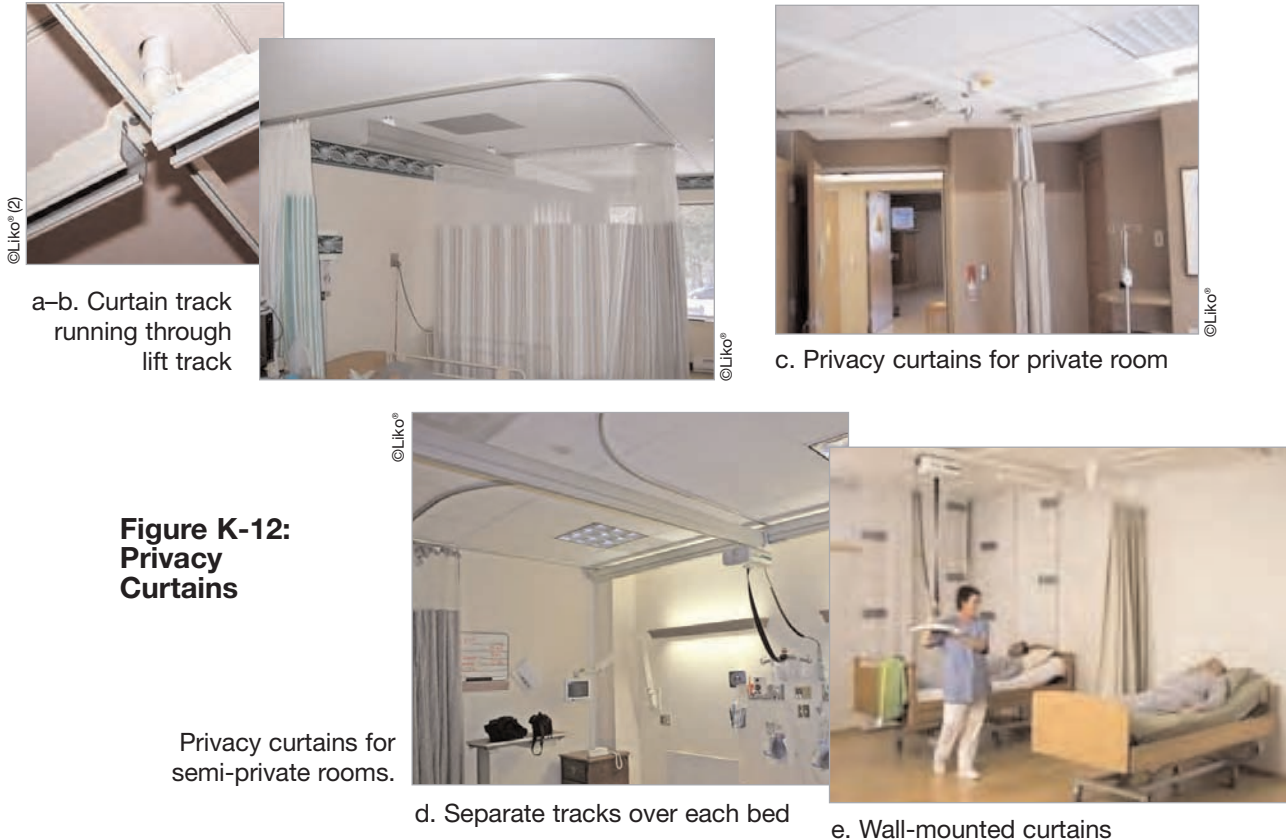

**Figure K-12:  
Privacy  
Curtains**

Privacy curtains for semi-private rooms.

- **Doors and door walls (structural and non-structural walls):** The use of tracking through structural walls creates more challenges in room-to-room tracking.
- **Fire/life safety code requirements**
- **Ceiling height:** Ceiling height must allow the minimum lifting range required for use of lifting equipment.
- **Motor maintenance:** Allow enough space between the track-end and wall for removal of the motor.
- **Motor charging:** Provide a code-compliant recharging location for the lift motor.
- **Storage space:** Provide storage space that allows immediate accessibility for the motor and hanger bar when they are not in use but keeps the lift system away from areas of foot travel.
- **Headwall design:** Some designs prevent installation of tracks and thus use of ceiling lifts, especially in ICU areas.
- **Location/design of privacy curtains:** The use of privacy curtains is affected by the installation of traverse track designs. Use of privacy screens, curtains attached to booms, and other unique designs may be a suitable alternative to curtains hung from the ceiling. In some situations, privacy curtains can be split and then fastened together with Velcro or buttons. (See Figure K-12.)

# APPENDIX L

## Storage Requirements for PHAM Equipment

This appendix provides information to help determine how much storage space is needed for several types of patient handling and movement (PHAM) equipment.

### Lift Storage Space Requirements

- Use average (non-expanded base) dimensions (given below or from the lift manufacturer) to determine the minimum space necessary for the required number of both types of lifts.
- Space requirements will vary with lift weight capacities. The footprint of bariatric floor-based lifts will be greater than that of the non-bariatric lifts given below.
- Space requirements will depend on the storage arrangement (side by side, end to end, or a combination).

### Lift Footprint/Dimensions

Consult with staff and/or the lift manufacturer for true dimensions.

- Average sit-to-stand lift =  
27 in. wide x 43 in. long (~8 sf)  
(Expanded base width = ~ 50 in.)
- Average floor-based sling lift =  
27 in. wide x 54 in. long (~10 sf)  
(Expanded base width = ~ 60 in.)

### Example (NHCU)

One sit-to-stand (STS) lift is recommended for every 8–10 partially weight-bearing patients/residents, and one floor-based sling lift (FBSL) is recommended for each unit or floor. On an NHCU with 60 beds and an average of 25 residents who are partially weight-bearing, storage accommodations for 3 STS lifts and one FBSL will be needed. Using the above average non-expanded base dimensions to determine space necessary for these 4 lifts, 34 sf should be allotted for these 4 lifts.

STS space requirements:

$$27 \text{ in.} \times 43 \text{ in.} = 8 \text{ sf} \times 3 \text{ STS} = 24 \text{ sf}$$

FBSL space requirements:

$$27 \text{ in.} \times 54 \text{ in.} = 10 \text{ sf} \times 1 \text{ FBSL} = \frac{10 \text{ sf}}{34 \text{ sf}}$$

**Total** space requirements:  $\frac{34 \text{ sf}}$

### Calculating Storage Space Requirements for Floor-Based Lifts

The recommendations given here are based on a unit or facility's ceiling lift coverage, as mentioned elsewhere in this white paper.

Space requirements are based on the following:

- The type of clinical unit
- The number of patients on the unit
- Footprint/dimensions of floor-based lifts

To determine minimum space requirements for storing portable/floor-based lifts on each unit:

1. Multiply the number of sit-to-stand (STS) lifts required for the unit/area (as derived from Table J-2) by the space requirements for the lift(s) in use or to be purchased (for information about determining the lift footprint, see the sidebar).

$$\# \text{ STS lifts/unit} \times \text{lift footprint dimensions} = \text{sit-to-stand lift space requirement (sf)}$$

2. Multiply the number of floor-based sling lifts (FBSL) required for the unit/area (as derived from Table J-2) by the space requirements for the lift/s in use or to be purchased (see sidebar).

$$\# \text{ FBSL/unit} \times \text{lift footprint dimensions} = \text{FBSL Space requirement (sf)}$$

3. Add the space requirements for the sit-to-stand and floor-based sling lifts to obtain the minimum storage space requirements for the portable/floor-based lifts.

$$\text{FBSL} + \text{STS lift space requirements} = \text{TOTAL storage space requirements for portable lifts}$$

## Storage for Lift Accessories and Other Equipment

Storage space must also be provided for lift accessories and other related equipment.

### Sling and Hanger Bar Storage

Surplus slings should be stored in the same location as floor-based lifts. Provide hooks for hanging slings and/or shelving for storage of folded slings. Standard shelving is acceptable for storing an assortment of slings (see Figure L-1) and extra lift hanger bars (see Figure L-2).

In patient rooms, provide hooks for storing patient-specific slings. Slings assigned to a specific patient should be stored in the patient room to provide instant accessibility and ensure use compliance.

### Battery-Charging Equipment

Storage spaces for patient handling and movement equipment often include locations for charging batteries. For more information, refer to the requirements for battery charging in Guidelines text 1.2-5.2.2.2, quoted in Chapter 2 of this white paper.

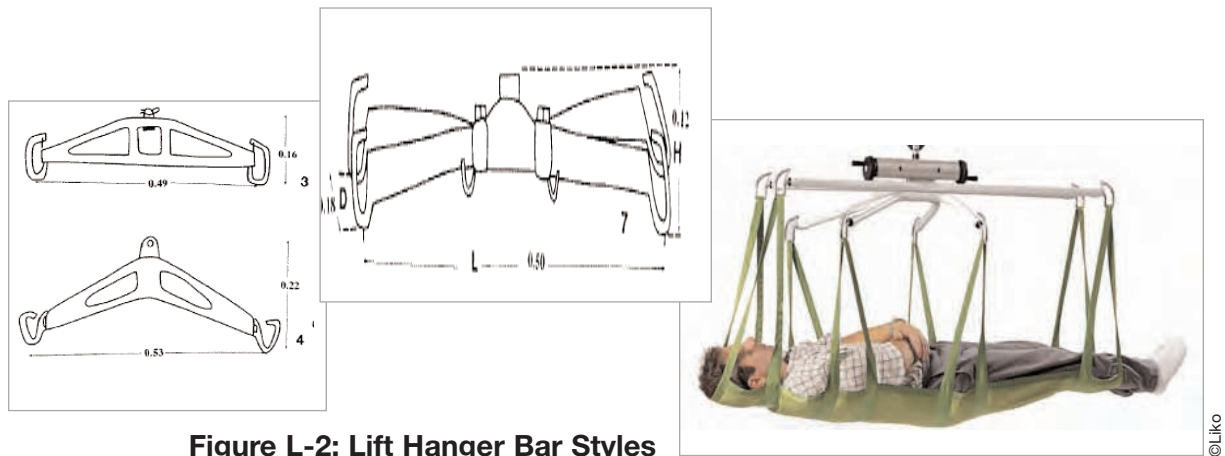

### Other Equipment

Standard shelving is used to store other patient handling and movement equipment, such as friction-reducing devices (Figure L-3) and air-assisted lateral transfer aids with a motor (Figure L-4).

### Storage for Infrequently Used Equipment

An equipment bank located in the basement or other out-of-the-way area of the health care facility is helpful for storing large, infrequently used equipment such as bariatric beds, portable bariatric (gantry) lifts, floor-based full body sling lifts with an eight-point hanger bar for a supine sling, and extra lifts. Such an area would need an electric supply for charging batteries.



© ArjoHuntleigh

**Figure L-3: Friction-Reducing Devices**



Slipp® (©Wright Products Inc.)



Hovermatt (©HoverTech)

**Figure L-4: Air-Assisted Lateral Transfer Device with Motor**  
(Air mattress folds into smaller size)



# APPENDIX M

## Infection Control Risk Assessment Matrix of Precautions for Construction and Renovation

### Step One:

Using the following table, *identify* the **Type of Construction Project Activity (Type A-D)**.

---

<b>TYPE A</b>	<b>Inspection and non-invasive activities</b> Includes, but is not limited to: <ul style="list-style-type: none"><li>■ Removal of ceiling tiles for visual inspection only (e.g., limited to 1 tile per 50 square feet)</li><li>■ Painting (but not sanding)</li><li>■ Wall-covering, electrical trim work, minor plumbing, and activities that do not generate dust or require cutting of walls or access to ceilings other than for visual inspection</li></ul>
<b>TYPE B</b>	<b>Small-scale, short duration activities that create minimal dust</b> Includes, but is not limited to: <ul style="list-style-type: none"><li>■ Installation of telephone and computer cabling</li><li>■ Access to chase spaces</li><li>■ Cutting of walls or ceiling where dust migration can be controlled</li></ul>
<b>TYPE C</b>	<b>Work that generates a moderate to high level of dust or requires demolition or removal of any fixed building components or assemblies</b> Includes, but is not limited to: <ul style="list-style-type: none"><li>■ Sanding of walls for painting or wall-covering</li><li>■ Removal of floor coverings, ceiling tiles, and casework</li><li>■ New wall construction</li><li>■ Minor ductwork or electrical work above ceilings</li><li>■ Major cabling activities</li><li>■ Any activity that cannot be completed within a single work shift</li></ul>
<b>TYPE D</b>	<b>Major demolition and construction projects</b> Includes, but is not limited to: <ul style="list-style-type: none"><li>■ Activities that require consecutive work shifts</li><li>■ Projects that require heavy demolition or removal of a complete cabling system</li><li>■ New construction</li></ul>

---

### **Step 1:** \_\_\_\_\_

Steps 1-3 and construction permit: Adapted with permission from V Kennedy, B Barnard, St Luke Episcopal Hospital, Houston TX; C Fine CA  
Steps 4-14: Adapted with permission from Fairview University Medical Center, Minneapolis, MN.  
Forms modified/updated and provided courtesy of Judene Bartley, ECSI Inc., Beverly Hills MI 2002. Updated 2009.

**Step Two:**

Using the following table, *identify* the **Patient Risk Groups** that will be affected. If more than one risk group will be affected, select the higher risk group:

Low Risk	Medium Risk	High Risk	Highest Risk
Office areas	Cardiology Echocardiography Endoscopy Nuclear medicine Physical therapy Radiology/MRI Respiratory therapy	CCU Emergency room Labor and delivery Laboratories (specimen) Medical units Newborn nursery Outpatient surgery Pediatrics Pharmacy Post-anesthesia care unit Surgical units	Any area for care of immunocompromised patients Burn unit Cardiac cath lab Central sterile supply Intensive care units Negative pressure isolation rooms Oncology Operating rooms, including C-section rooms

**Step 2:** \_\_\_\_\_

**Step Three:**

Match the **Patient Risk Group** (*Low, Medium, High, Highest*) with the planned **Construction Project Type** (*A, B, C, D*) on the following matrix, to find the **Class of Precautions** (*I, II, III or IV*) or level of infection control activities required. (Class I–IV and Color-Coded Precautions are delineated on the following page.)

**IC Matrix - Class of Precautions: Construction Project by Patient Risk**

Patient Risk Group	Construction Project Type			
	TYPE A	TYPE B	TYPE C	TYPE D
LOW	I	II	II	III/IV
MEDIUM	I	II	III	IV
HIGH	I	II	III/IV	IV
HIGHEST	II	III/IV	III/IV	IV

**Note:** Infection Control approval will be required when the construction activity and risk level indicate that Class III or Class IV control procedures are necessary.

**Step 3:** \_\_\_\_\_

**Description of Required Infection Control Precautions by Class**

	<b>During Construction Project</b>	<b>Upon Completion of Project</b>
<b>CLASS I</b>	<ol style="list-style-type: none"> <li>1. Use methods to execute work that minimize dust raised from construction operations.</li> <li>2. Immediately replace any ceiling tiles displaced for visual inspection.</li> </ol>	<ol style="list-style-type: none"> <li>1. Clean work area upon completion of task.</li> </ol>
<b>CLASS II</b>	<ol style="list-style-type: none"> <li>1. Provide active means to prevent airborne dust from dispersing into atmosphere.</li> <li>2. Water-mist work surfaces to control dust while cutting.</li> <li>3. Seal unused doors with duct tape.</li> <li>4. Block off and seal air vents.</li> <li>5. Place dust mat at entrance and exit of work area.</li> <li>6. Remove or isolate HVAC system in areas where work is being performed.</li> </ol>	<ol style="list-style-type: none"> <li>1. Wipe work surfaces with cleaner/disinfectant.</li> <li>2. Contain construction waste before transport in tightly covered containers.</li> <li>3. Wet mop and/or vacuum with HEPA-filtered vacuum before leaving work area.</li> <li>4. Upon completion, restore HVAC system where work was performed.</li> </ol>
<b>CLASS III</b>	<ol style="list-style-type: none"> <li>1. Remove or isolate HVAC system in area where work is being done to prevent contamination of duct system.</li> <li>2. Before construction begins, complete all critical barriers (i.e., sheetrock, plywood, plastic) to seal work area from non-work area or implement control cube method (cart with plastic covering and sealed connection to work site with HEPA vacuum for vacuuming prior to exit).</li> <li>3. Maintain negative air pressure within work site utilizing HEPA-equipped air filtration units.</li> <li>4. Contain construction waste before transport in tightly covered containers.</li> <li>5. Cover transport receptacles or carts. Tape covering unless solid lid.</li> </ol>	<ol style="list-style-type: none"> <li>1. Do not remove barriers from work area until completed project has been inspected by the owner's Safety and Infection Prevention &amp; Control departments and thoroughly cleaned by the owner's Environmental Services department.</li> <li>2. Remove barrier materials carefully to minimize spreading of dirt and debris associated with construction.</li> <li>3. Vacuum work area with HEPA-filtered vacuums.</li> <li>4. Wet mop area with cleaner/disinfectant.</li> <li>5. Upon completion, restore HVAC system where work was performed.</li> </ol>
<b>CLASS IV</b>	<ol style="list-style-type: none"> <li>1. Isolate HVAC system in area where work is being done to prevent contamination of duct system.</li> <li>2. Before construction begins, complete all critical barriers (i.e. sheetrock, plywood, plastic) to seal area from non-work area or implement control cube method (cart with plastic covering and sealed connection to work site with HEPA vacuum for vacuuming prior to exit).</li> <li>3. Maintain negative air pressure within work site utilizing HEPA-equipped air filtration units.</li> <li>4. Seal holes, pipes, conduits, and punctures.</li> <li>5. Construct anteroom and require all personnel to pass through this room so they can be vacuumed using a HEPA vacuum cleaner before leaving work site or they can wear cloth or paper coveralls that are removed each time they leave work site.</li> <li>6. All personnel entering work site are required to wear shoe covers. Shoe covers must be changed each time the worker exits the work area.</li> </ol>	<ol style="list-style-type: none"> <li>1. Do not remove barriers from work area until completed project has been inspected by the owner's Safety and Infection Prevention &amp; Control departments and thoroughly cleaned by the owner's Environmental Services department.</li> <li>2. Remove barrier material carefully to minimize spreading of dirt and debris associated with construction.</li> <li>3. Contain construction waste before transport in tightly covered containers.</li> <li>4. Cover transport receptacles or carts. Tape covering unless solid lid.</li> <li>5. Vacuum work area with HEPA-filtered vacuums.</li> <li>6. Wet mop area with cleaner/disinfectant.</li> <li>7. Upon completion, restore HVAC system where work was performed.</li> </ol>

**Step 4:** Identify the areas surrounding the project area, assessing potential impact.

Unit Below	Unit Above	Lateral	Lateral	Behind	Front
Risk Group	Risk Group	Risk Group	Risk Group	Risk Group	Risk Group

**Step 5:** Identify specific site of activity (e.g., patient rooms, medication room, etc.).

---

**Step 6:** Identify issues related to ventilation, plumbing, electrical systems in terms of the occurrence of probable outages.

---

**Step 7:** Identify containment measures, using prior assessment. What types of barriers (e.g., solid wall barriers)? Will HEPA filtration be required?

---

(Note: Renovation/construction area shall be isolated from occupied areas during construction and shall be negative with respect to surrounding areas.)

**Step 8:** Consider potential risk of water damage. Is there a risk due to compromising structural integrity (e.g., wall, ceiling, roof)?

**Step 9:** Work hours: Can or will the work be done during non-patient care hours?

**Step 10:** Do plans allow for an adequate number of isolation/negative airflow rooms?

**Step 11:** Do the plans allow for the required number and type of hand-washing sinks?

**Step 12:** Does the infection prevention and control staff agree with the minimum number of sinks for this project? (Verify against FGI Design and Construction Guidelines for types and area.)

**Step 13:** Does the infection prevention and control staff agree with the plans relative to clean and soiled utility rooms?

**Step 14:** Plan to discuss the following containment issues (e.g., traffic flow, environmental services—housekeeping, debris removal—how and when) with the project team.

---

**Appendix:** Identify and communicate the responsibility for project monitoring that includes infection prevention and control concerns and risks. The ICRA may be modified throughout the project, but revisions must be communicated to the project manager.

<b>Infection Control Construction Permit</b>						
					Permit No.:	
Location of construction:				Project start date:		
Project coordinator:				Estimated duration:		
Contractor performing work:				Permit expiration date:		
Supervisor:				Telephone:		
YES	NO	CONSTRUCTION ACTIVITY	YES	NO	INFECTION CONTROL RISK GROUP	
		TYPE A: Inspection, non-invasive activity			GROUP 1: Low Risk	
		TYPE B: Small scale, short duration, moderate to high levels			GROUP 2: Medium Risk	
		TYPE C: Activity generates moderate to high levels of dust, requires more than one work shift for completion			GROUP 3: Medium/High Risk	
		TYPE D: Major duration and construction activities Requiring consecutive work shifts			GROUP 4: Highest Risk	
CLASS I		1. Execute work using methods that minimize dust raised by construction operations. 2. Immediately replace any ceiling tiles displaced for visual inspection. 3. Minor demolition for remodeling				
CLASS II		1. Provide active means to prevent airborne dust from dispersing into atmosphere. 2. Water-mist work surfaces to control dust while cutting. 3. Seal unused doors with duct tape. 4. Block off and seal air vents. 5. Wipe surfaces with cleaner/disinfectant. 6. Contain construction waste before transport in tightly covered containers. 7. Wet mop and/or vacuum with HEPA-filtered vacuum before leaving work area. 8. Place dust mat at entrance and exit of work area. 9. Isolate HVAC system in areas where work is being performed; restore when work completed.				
CLASS III		1. Obtain infection control permit before construction begins. 2. Isolate HVAC system in area where work is being done to prevent contamination of the duct system. 3. Complete all critical barriers or implement control cube method before construction begins. 4. Maintain negative air pressure within work site utilizing HEPA-equipped air filtration units. 5. Do not remove barriers from work area until complete project is checked by Infection Prevention & Control and thoroughly cleaned by Environmental Services. 6. Vacuum work with HEPA-filtered vacuums. 7. Wet mop with cleaner/disinfectant 8. Remove barrier materials carefully to minimize spreading of dirt and debris associated with construction. 9. Contain construction waste before transport in tightly covered containers. 10. Cover transport receptacles or carts. Tape covering. 11. Upon completion, restore HVAC system where work was performed.				
Date						
Initial						
CLASS IV		1. Obtain infection control permit before construction begins. 2. Isolate HVAC system in area where work is being done to prevent contamination of duct system. 3. Complete all critical barriers or implement control cube method before construction begins. 4. Maintain negative air pressure within work site utilizing HEPA-equipped air filtration units. 5. Seal holes, pipes, conduits, and punctures appropriately. 6. Construct anteroom and require all personnel to pass through it so they can be vacuumed using a HEPA vacuum cleaner before leaving work site, or they can wear cloth or paper coveralls that are removed each time they leave the work site. 7. All personnel entering work site are required to wear shoe covers. 8. Do not remove barriers from work area until the completed project is checked by Infection Prevention & Control and thoroughly cleaned by Environmental Services. 9. Vacuum work area with HEPA-filtered vacuums. 10. Wet mop with disinfectant. 11. Remove barrier materials carefully to minimize spreading of dirt and debris associated with construction. 12. Contain construction waste before transport in tightly covered containers. 13. Cover transport receptacles or carts. Tape covering. 14. Upon completion, restore HVAC system where work was performed.				
Date						
Initial						
Additional requirements:						
_____				_____ Exceptions/additions to this permit		
Date Initials				Date Initials are noted by attached memoranda.		
Permit request by:				Permit authorized by:		
Date:				Date:		

# APPENDIX N

## Bariatric Equipment Safety Checklist

### HOSPITAL BED

Weight limit: \_\_\_\_\_ lbs.  
Side rail support: \_\_\_\_\_ lbs.  
Bed scale?  Yes  No  
If yes, weight limit: \_\_\_\_\_ lbs.  
Width of bed: \_\_\_\_\_ in.  
Adjustable for width?  Yes  No  
Mattress type  
 Pressure relief  
 Pressure reduction o Alternating  
 Rotational  
 Other \_\_\_\_\_

### WHEELCHAIR

Weight limit: \_\_\_\_\_ lbs.  
Width: \_\_\_\_\_ in.  
Seat height: \_\_\_\_\_ in.  
Handle width: \_\_\_\_\_ in.  
Powered?  Yes  No

### STRETCHER

Weight limit: \_\_\_\_\_ lbs.  
Width: \_\_\_\_\_ in.  
Seat height: \_\_\_\_\_ in.  
Handle width: \_\_\_\_\_ in.  
Powered?  Yes  No

### BEDSIDE COMMODE/SHOWER CHAIR

Weight limit: \_\_\_\_\_ lbs.  
Seat width: \_\_\_\_\_ in.  
Adjustable height?  Yes  No

### SCALES

Weight limit: \_\_\_\_\_ lbs.  
Width: \_\_\_\_\_ in.

### WALKER

Weight limit: \_\_\_\_\_ lbs.  
Width: \_\_\_\_\_ in.

### BATHROOM

Doorframe width: \_\_\_\_\_ in.  
Shower door width: \_\_\_\_\_ in.  
Weight limits  
Toilet: \_\_\_\_\_ lbs.  
Wall-mounted grab bars: \_\_\_\_\_ lbs.  
Wall-mounted skin: \_\_\_\_\_ lbs.

### PATIENT CARE ENVIRONMENT

Patient chair  
Weight limit: \_\_\_\_\_ lbs.  
Width: \_\_\_\_\_ in.  
Seat height: \_\_\_\_\_ in.  
Geri/cardiac chair  
Weight limit: \_\_\_\_\_ lbs.  
Width: \_\_\_\_\_ in.  
Seat height: \_\_\_\_\_ in.

### TRANSFER DEVICES

Lateral transfer devices  
Weight limit: \_\_\_\_\_ lbs.  
Width: \_\_\_\_\_ in.  
Powered?  Yes  No  
Full-body sling  
Weight limit: \_\_\_\_\_ lbs.  
Powered?  Yes  No  
Goes to floor?  Yes  No  
Sit-to-stand devices  
Weight limit: \_\_\_\_\_ lbs.  
Width: \_\_\_\_\_ in.  
Powered?  Yes  No

### ANCILLARY DEPARTMENTS

Door widths: \_\_\_\_\_ in.  
X-ray table  
Weight limit: \_\_\_\_\_ lbs.  
Width: \_\_\_\_\_ in.  
CT scan equipment  
Weight limit: \_\_\_\_\_ lbs.  
Width: \_\_\_\_\_ in.  
OR table  
Weight limit: \_\_\_\_\_ lbs.  
Width: \_\_\_\_\_ in.  
Emergency room equipment  
Weight limit: \_\_\_\_\_ lbs.  
Width: \_\_\_\_\_ in.  
Waiting room furniture  
Weight limit: \_\_\_\_\_ lbs.  
Width: \_\_\_\_\_ in.  
Exam room table  
Weight limit: \_\_\_\_\_ lbs.  
Width: \_\_\_\_\_ in.

*NOTE: All patient care devices and supplies should be carefully evaluated for bariatric capacity.*

# APPENDIX O

## Making Critical In-House Connections for PHAMP Success

A win-win situation occurs when the facility safe patient handling and movement (SPHM) leader is included in the facility environment of care or safety committee, or accident review board. Simple presentation of status reports to these bodies, even when given by the SPHM leader as a guest, fosters program success by educating those who would not normally be aware of the patient handling and movement program (PHAMP).

Such face-to-face meetings have many benefits, including keeping the committee or board apprised of PHAMP progress. Even more importantly, the facility departments that usually belong to bodies concerned with safety issues are those departments particularly important to the success of a safety program. Thus, these meetings provide a valuable opportunity to facilitate working associations between entities that can influence implementation of a PHAMP.

### Safety and Occupational Staff

Safety and occupational health staff are charged with providing safe environments for staff and patients, and the close relationship between staff safety and patient safety often means patient safety staff and risk managers are naturally interested in PHAMPs. During development and implementation of a PHAMP, their input can be valuable and should be pursued.

One of the most important contributions safety and occupational staff members can make to the PHAMP is provision of information on staff patient handling injuries in the facility. They will most likely be the source of accident reports for review, and they may assist in tracking injuries and developing reports for leadership. In addition, some safety staff members have formal education in ergonomics and may help facility coordinators understand that science and even conduct ergonomic evaluations. Staff members who follow workers' compensation claims will also be helpful

in pulling cost data for use in cost-benefit analyses.

That patient handling and movement (PHAM) technology improves the quality of care for patients is even more reason for safety and occupational staff interest and involvement in such programs. These staff members can provide important information and data showing the benefits of using PHAM equipment for patient outcomes, such as reductions in the incidence of falls, skin tears, and other adverse events. They may be able to help make the case for PHAMP implementation and the introduction of patient handling technology.

### Middle Management

Support or lack of support from frontline supervisors and other middle managers can make or break a PHAMP. Forging alliances and fostering good communication with these groups through one-on-one meetings, supervisor meetings, and other means are essential. Always meet face-to-face and one-on-one with each of these key players to educate them and enlist their support. For successful program implementation, these managers must help the facility PHAMP coordinator select unit/area peer leaders, allow employees to spend time performing as peer leaders, allow time for staff training on new equipment and PHAMP program elements, and promote the ideals behind safe patient handling and movement.

### Frontline Staff

The time to introduce the safe patient handling and movement (SPHM) concept to frontline staff is early on, not after PHAM equipment has been introduced on the unit/area. A variety of techniques can be used to increase their awareness and interest:

- Provide an overview or awareness training for frontline staff.
- Have each unit/area complete Tool 1: Perception of High-Risk Tasks Survey (in Appendix H) by shift. Collate the results by shift and post them in each unit/area.
- Ensure that staff members are involved in evaluating potential PHAM equipment during equipment trials and/or equipment fairs. Make sure they know their voices are being heard by having them complete equipment rating survey forms (Appendix G).
- Involve as many staff members as possible in the patient care ergonomic evaluation process (Appendix E). Those who show keen interest may be appropriate as PHAMP unit/area peer leaders.

### **Facility Educators**

Because comprehensive training is critical for peer leaders and staff when a new PHAMP is introduced, inclusion of facility educators in training development is important. Who actually conducts and coordinates the training varies from facility to facility. Remember to include educators from both nursing and facility staffs, as training is required for all who move and handle patients—physical therapists, radiology technicians, and others, as well as nurses.

### **Facility Procurement Staff**

Communication with staff members responsible for procurement and contracting must be started early in the PHAMP for a number of reasons:

- Close association with purchasing staff is important so they will understand why PHAM equipment must be selected with staff input rather than on a cost-only basis. (It is integral to the philosophy of a PHAMP that staff who will use PHAM equipment have input into equipment purchase decisions as well as the program development process overall.) Include purchasing staff in preparations for equipment trials on the unit or during equipment fairs. Usually contracting staff make initial contact with the vendors who will be asked to exhibit or test their equipment. (See
- Appendix G for information on holding equipment fairs and conducting equipment trials.)
- Purchasing or contracting staff are responsible for making the actual purchase of the equipment, but they may require the facility coordinator to develop a statement of work (SOW) or purchase order. Since facility coordinators often come from clinical backgrounds, a good working relationship with contracting staff can be very helpful.
- The job of purchasing or contracting staff is to work with vendors. They know how to make the best deals with vendors and how to follow appropriate organizational policies and procedures, most of which are unfamiliar to facility champions with clinical backgrounds.

### **Facility Management Staff**

Facility management/engineering/project management staff members can be allies in implementation of a PHAMP in several ways, and it is important to have their involvement from the very beginning. Due to their expertise, they must be included in the following activities:

- Ergonomic site visit walk-through: It is important for facility management staff to accompany the site visit team as they walk through the facility and make recommendations for PHAM equipment. The facility staff will know the structural and environmental issues (asbestos, lead) that will affect certain types of lift track installation, and this information will ensure the structural integrity of the building is maintained if fixed lifts are installed. Be sure to have facility staff look at patient and toilet room space constraints and conflicts posed by existing ceiling-hung equipment. While they are with you, have them help find hidden storage areas. Often, it may be feasible to create additional storage for PHAM equipment and accessories by freeing up space that contains sinks or hoppers that are no longer in use.
- Equipment evaluations: Be sure to include facility management staff in PHAM equipment evaluations and ask them to consider ease of maintenance and repair.
- Lift installations: Facility management staff members oversee the installation of fixed-lift systems.



## **Environmental Services Staff**

Housekeeping staff will most likely be responsible for cleaning PHAM equipment within the room, especially ceiling lifts. In their eyes, installation of a lift system gives them “one more thing” to keep clean. Recognizing that reservations regarding a potential increase in workload are normal, work with these staff members to make the additional work as easy as possible.

## **Supply/Processing/Distribution (SPD) Staff**

Depending on the facility, supply/processing/distribution staff may be responsible for:

- Storing equipment and accompanying materials (e.g., slings, air mattresses)
- Laundering slings
- Cleaning PHAM equipment
- Distributing equipment to units/areas as needed

Working with these staff members to develop well-thought-out procedures for these activities will improve the lives of all involved and facilitate use of PHAM equipment.

## **Infection Preventionists**

Infection control professionals will ensure that PHAM equipment is suitable for its proposed use from an infection control standpoint and that disinfection/sterilization will be achievable. Bringing these staff members into your planning process early on will benefit both the PHAMP and the infection prevention effort.

## **Unions**

Union representatives, by definition, support staff rights and safety, and so generally unions are very supportive of SPHM initiatives; they can be significant partners in promoting your cause with leadership and others. As is their job, they will be very protective of their workers and may want to review the method for selecting peer leaders to ensure that all who wish to become a peer leader are given an equal opportunity. Understandably, unions may resist collateral duty positions for peer leaders, not wanting to add responsibility without compensation or to overwork an employee. Keep union representatives apprised of PHAMP activities from the beginning, and include their representation in your facility SPHM team.

# APPENDIX P

## PHAMP Element Descriptions

This appendix provides descriptions of the program elements that make up a patient handling and movement program (PHAMP).

### Peer Leaders

Peer leaders have been identified as key to the success of a PHAMP.<sup>1, 2</sup> These individuals obtain their expertise through extra training and work in the field. As staff resource persons and equipment “super users,” they are available to answer their co-workers’ questions about use of patient handling and movement (PHAM) equipment and PHAMP elements. As well, their presence is crucial for staff compliance with use of PHAM equipment and tools.

Another vital role of peer leaders is transfer of knowledge. In a new model for the education of caregivers, PHAMP peer leaders, rather than education staff, train co-workers. They serve as unit/area safe patient handling and movement (SPHM) champions, and—even more important—as SPHM change agents in their areas, where they are responsible for facilitating significant change in the way their co-workers perform their jobs. The peer leaders’ value in this regard cannot be overstated. Finally, peer leaders can help assess how implementation of a PHAMP is progressing, and their feedback is critical to program success. Appendix S offers a log for capturing the unit activity and program status of SPHM peer leaders.

Although each peer leader is a “leader” in his or her own right, peer leaders as a group require a group leader, and the facility SPHM coordinator should assume this role.<sup>3</sup> Without someone in this position, peer leader programs tend to fade away, even if one or two facility peer leaders take on a broader leadership role. The support of a dedicated program leader can expand the activity of peer leaders on facility units and prevent existing PHAMP elements from losing their impact.

Peer leaders are frontline staff who work in clinical units or areas where patient handling and

movement occurs, including radiology, therapy, and nursing units and other procedure and treatment areas. One peer leader per shift per unit is recommended to ensure availability around the clock. Because peer leaders may leave their unit, position, or organization, early thought must be given to succession planning to facilitate a smooth transition between peer leaders.

The VHA implemented a peer leader program as the first element in its PHAMP as a way to facilitate staff buy-in and assistance in program roll-out on the units. An SPHM unit binder with information to support peer leaders in program implementation, equipment tracking, and other unit SPHM issues; a weekly process log for capturing peer leader activity; and other resources developed by the VHA are available at [www.visn8.va.gov/patientsafety-center/safePtHandling/default.asp](http://www.visn8.va.gov/patientsafety-center/safePtHandling/default.asp). Further information is referenced in the footnotes.<sup>4, 5</sup>

### Safety Huddles

At the VHA, after the SPHM peer leaders were in place on their unit, their first function was to train co-workers in the use of safety huddles.<sup>6</sup> Safety huddles offer a venue for unit staff to share ideas on patient and staff safety issues, best practices, and solutions for problematic unit concerns. They provide a forum for reviewing near-miss and injury incidents with the goal of preventing their recurrence. Most important, they provide an opportunity for staff to discuss problems and come up with solutions.

Brainstorming in a safety huddle is guided using the five questions below:

1. What happened?
2. What was supposed to happen?
3. What accounts for the difference?
4. How could the same outcome be avoided in the future?
5. What is the follow-up plan?

Safety huddles do not gather information that will serve as evidence for punishment; only

solutions and recommendations are recorded. This approach facilitates candor and openness among the staff.

Knowledge transfer mechanisms like the safety huddle have been used in some organizations very successfully, especially in the military. “After-action reviews,” as they are called in the military, are ingrained in the culture; consequently, few activities take place without such an opportunity to debrief those who were involved in the action and to review the incident with those who were not involved. The goal is to take information from one person or group and share it with others so that negative outcomes can be prevented and positive ones repeated.

The VHA has found that safety huddles help facilitate staff buy-in and contribute to successful PHAMP roll-out on the units. Safety huddle resources, such as a brochure and templates for collecting information, are found at [www.visn8.va.gov/patientsafetycenter/safePtHandling/default.asp](http://www.visn8.va.gov/patientsafetycenter/safePtHandling/default.asp). A comprehensive discussion of safety huddles and “after-action reviews” is also found in *Safe Patient Handling and Movement: A Practical Guide for Health Care Professionals*.<sup>7</sup>

### **Patient Care Ergonomic Evaluations**

After the VHA peer leaders were in place, ergonomic evaluations were conducted, and PHAM equipment recommendations were generated based on information gathered from unit staff and the characteristics of the patient population of the unit/area under consideration. These recommendations were general, such as acquiring ceiling lifts, sit-to-stand lifts, or air-assisted lateral transfer devices, and usually did not specify a particular manufacturer unless a one-of-a-kind piece of equipment was suggested. For more information, see Appendix E: Patient Care Ergonomic Evaluation Process.

### **Patient Handling Equipment**

Once a health care facility has decided to utilize PHAM equipment, the next step is to choose, acquire, and install the equipment.

**Selection.** It is generally accepted that PHAM equipment and aides are key to reducing the risk

of injury for caregivers, improving the quality of care for patients, and increasing mobilization of patients. However, if the equipment chosen is not appropriate for a facility’s patient population or is not easy to use, its purchase may turn out to be a costly mistake. For this reason, once appropriate PHAM equipment types have been identified through the PCE process, staff should test the equipment to determine what brand is best for their patient population and most user-friendly for them.

Holding PHAM equipment fairs and trials can ensure staff participation in the equipment selection process, which will promote staff acceptance of the equipment and the PHAMP. Refer to Appendix C: Patient Handling and Movement Equipment Categories for descriptions of different types of PHAM equipment and to Appendix G: Equipment Evaluation and Selection Process for information on making good equipment purchase decisions. Chapter 2 covers important design considerations for specifying equipment.

**Procurement.** Due to the great variation in procurement criteria and activities among organizations, it is best to connect with your purchasing department before contacting vendors, to ensure that organizational policies are followed.

**Installation.** During this phase, the following activities will take place:

- Coordination with facility management staff
- Coordination with supervisors/staff in the areas where installation will occur
- Check that the correct equipment has been received
- Check that the correct equipment has been installed in the correct room or area
- Check for satisfactory completion of installations

Each facility and organization will have its own methods for facilitating these activities. It is critical for facility SPHM coordinators to be familiar with them and to develop working relationships with facility management staff and other entities.

### **Assessments, Algorithms, and Guidelines for Safe Patient Handling**

Research has been conducted to identify the patient handling tasks that put caregivers at greatest risk for injury (Appendix A), and many of

**Table P-1: Algorithms for Safe Patient Handling\***

Algorithm	Task
1	Transfer from bed to chair, chair to toilet, chair to chair, or car to chair and vice versa
2	Lateral transfer from bed to stretcher/trolley and vice versa
3	Transfer from chair to stretcher or chair to exam table and vice versa
4	Reposition in bed (side-to-side, up in bed)
5	Reposition in wheelchair and dependency chair
6	Transfer a patient up from the floor
Bariatric 1	Bariatric transfer from bed to chair, chair to toilet, or chair to chair or vice versa
Bariatric 2	Bariatric lateral transfer from bed to stretcher or trolley and vice versa
Bariatric 3	Bariatric reposition in bed (side-to-side, up in bed)
Bariatric 4	Bariatric reposition in wheelchair, chair, or dependency chair
Bariatric 5	Patient handling tasks requiring sustained holding of a limb/access
Bariatric 6	Bariatric transporting (stretcher, wheelchair, walker)
Bariatric 7	Toileting tasks for the bariatric patient
Bariatric 8	Transfer a bariatric patient up from the floor

\*Adapted from "Algorithms for Safe Patient Handling and Movement," posted at [www.visn8.va.gov/patientsafetycenter/safePtHandling/default.asp](http://www.visn8.va.gov/patientsafetycenter/safePtHandling/default.asp).

these "high-risk" tasks have ergonomic control measures (PHAM equipment) that decrease their risk. Consequently, these tasks have been the focus for development of ergonomic clinical algorithms and guidelines that incorporate equipment interventions to decrease injuries and the risk of injury. Before these algorithms and guidelines can be utilized for a patient, however, an assessment of the patient's moving and handling needs must be completed.<sup>8, 9, 10</sup> Use of such an assessment, along with algorithms specific to each type of high-risk task, helps staff select appropriate patient handling technology for each patient's needs. In patient care areas where the clinical status of patients is relatively constant, written recommendations are generated to facilitate consistency in transfer of information from staff to staff and shift to shift.<sup>11, 12, 13</sup> In clinical areas with patients whose clinical status changes rapidly, the algorithms and/or guidelines should be readily available on site and staff trained in how to use them. Suggestions for promoting them include posting the guidelines/algorithms in patient rooms or break rooms or hanging laminated copies on equipment.

After PHAM equipment had been introduced and staff trained, the VHA program put the "Patient Assessment, Care Planning and Algorithms for Safe

Patient Handling" ("algorithms") into practice to help staff select the most appropriate equipment for each high-risk task based on specific patient characteristics and requirements.<sup>14</sup> (See Table P-1 for a list of algorithms developed by the VHA and Figure P-1 for a sample algorithm.) Later, staff with expertise in specific clinical areas found they needed ergonomic guidelines specific to their clinical areas and patient characteristics. As a result, the Association of periOperative Registered Nurses (AORN)<sup>15</sup> and the National Association of Orthopedic Nurses (NAON)<sup>16</sup> developed ergonomic guidelines and algorithms. The NAON guidelines are found at [www.orthonurse.org/ResearchandPractice/SafePatientHandling/tabid/403/Default.aspx](http://www.orthonurse.org/ResearchandPractice/SafePatientHandling/tabid/403/Default.aspx), and the AORN guidelines can be purchased from [www.aornbookstore.org/product/product.asp?sku=MAN167&mscssid=KA8KPFTXNHFW8HXVNCDFNM3XJP0W4HXF](http://www.aornbookstore.org/product/product.asp?sku=MAN167&mscssid=KA8KPFTXNHFW8HXVNCDFNM3XJP0W4HXF). The American Physical Therapy Association (APTA) has also recognized the importance of focused guidelines and is in the process of developing them.

### **Safe Patient Handling and Movement Policy**

A SPHM policy ties all of the PHAMP elements together and gives strength to the program. Such

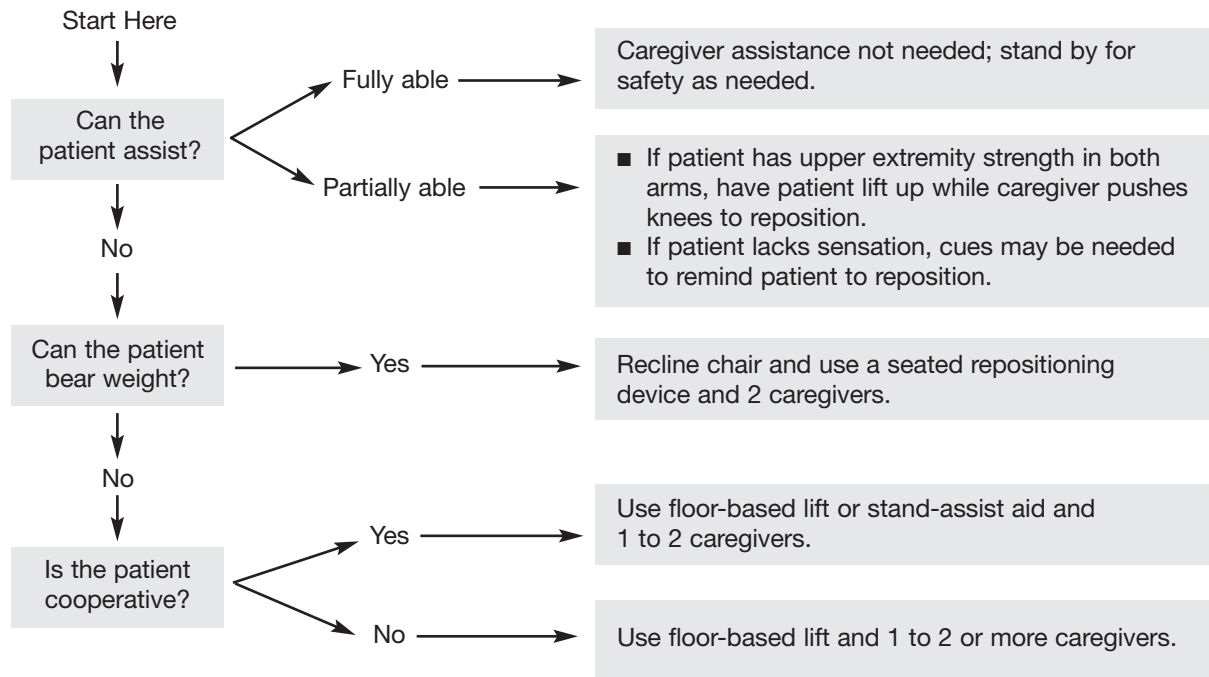
**Figure P-1: Algorithm 5—Reposition in Wheelchair and Dependency Chair****Notes**

1. Make sure the chair wheels are locked.
2. Take full advantage of chair functions (e.g., move a chair that reclines or use the armrest of a chair to facilitate repositioning).
3. During any patient transfer task, if any caregiver is required to lift more than 35 lbs. of the patient's weight, the patient should be considered to be fully dependent and assistive devices should be used. [T. Waters "When is it safe to manually lift a patient?" in *American Journal of Nursing*, 107, no. 8 (2007), 53–59.]

a policy is developed prior to PHAM equipment introduction, but cannot be put into practice and enforced until the equipment is in place and staff members have received training on its use and on the program elements. A policy template can be found at [www.visn8.va.gov/patientsafetycenter/safePtHandling/default.asp](http://www.visn8.va.gov/patientsafetycenter/safePtHandling/default.asp).

**Lift Teams**

A lift team has been defined as “two physically fit people, competent in lifting techniques, working together, using mechanical equipment to accomplish high-risk patient transfers.”<sup>17</sup> However, lift teams were often understood to be a team of men (usually) whose job is to manually lift and move patients. When such an *incorrect* interpretation of a lift team is the standard procedure in a facility, the staff members involved are placed at great ergonomic risk. True lift teams are those with special education in patient handling and movement and the use of patient handling tech-

nology. They are mandated to move patients only with proper patient handling assistive devices?never manually. When properly implemented, lift team programs can be quite successful and allow busy nursing staff to complete nursing tasks other than moving and lifting patients. However, lift teams must be adequately staffed so their help and expertise is available when needed on all shifts and in all locations of a hospital. Otherwise, if nursing staff must expedite a patient transfer without the lift team (either before the team arrives or because the team is busy elsewhere), the result may be detrimental to the patient and/or the staff member. The staff member may not have experience in using PHAM equipment on a day-to-day basis and thus may use it without full competency or choose to perform the patient handling activity manually. As noted, with sufficient staffing and use of appropriate equipment, lift teams provide busy staff with much needed assistance.

## Endnotes

- 1 M. Matz, "Unit-based peer safety leaders to promote safe patient handling," in *Safe Patient Handling and Movement: A Practical Guide for Health Care Providers*, edited by A. L. Nelson (New York: Springer Publishing Company, 2005).
- 2 H. Knibbe, "Ergonomic approach in the Netherlands: Experience," presentation at the 5th Annual Safe Patient Handling and Movement Conference, St. Pete Beach, FL (2005).
- 3 M. Matz, "Patient handling (lifting) equipment coverage & space recommendations" (Internal VHA document presented to Director, VHA, Occupational Health Program, 2007).
- 4 Matz, "Unit-based peer safety leaders to promote safe patient handling."
- 5 M. Matz et al., "Back injury prevention in health care," in *Handbook of Modern Hospital Safety, 2nd ed.*, W. Charney, ed. (New York: CRC Press, Taylor & Francis Group, 2010).
- 6 M. Matz, "After-action reviews," in *Safe Patient Handling and Movement: A Practical Guide for Health Care Providers*, A. L. Nelson, ed. (New York: Springer Publishing Company, 2005).
- 7 Matz, "Unit-based peer safety leaders to promote safe patient handling."
- 8 S. Hignett et al., "Evidence-based patient handling: systematic review," *Nursing Standard* 17, no. 33 (2003): 33–36.
- 9 A. L. Nelson, ed., *Patient Care Ergonomics Resource Guide: Safe Patient Handling and Movement* (Tampa: Veterans Administration Patient Safety Center of Inquiry, 2001).
- 10 A. Nelson et al., "Algorithms for safe patient handling and movement," *American Journal of Nursing* 103, no. 3 (2003): 32–34.
- 11 A. L. Nelson, ed., *Patient Care Ergonomics Resource Guide: Safe Patient Handling and Movement*.
- 12 A. Nelson et al., "Algorithms for safe patient handling and movement," *American Journal of Nursing*, 103, no. 3 (2003), 32-4.
- 13 Nelson, "Algorithms for safe patient handling and movement."
- 14 Nelson, *Patient Care Ergonomics Resource Guide*.
- 15 AORN Workplace Safety Taskforce, *Safe Patient Handling and Movement in the Perioperative Setting* (Denver, CO: Association of periOperative Registered Nurses [AORN], 2007).
- 16 C. A. Sedlak, M. O. Doheny, A. Nelson & T. R. Waters, "Development of the National Association of Orthopaedic Nurses guidance statement on safe patient handling and movement in the orthopaedic setting," *Orthopaedic Nursing*, Supplement to 28, no. 25 (2009): 2–8. Retrieved 10/1/09 from [www.orthonurse.org/ResearchandPractice/SafePatientHandling/tabid/403/Default.aspx](http://www.orthonurse.org/ResearchandPractice/SafePatientHandling/tabid/403/Default.aspx).
- 17 J. Meittunen, K. Matzke, H. McCormack & S. C. Sobczak, "The effect of focusing ergonomic risk factors on a patient transfer team to reduce incidents among nurses associated with patient care." *Journal of Healthcare Safety, Compliance and Infection Control* 2, no. 7 (1999): 306–12.

## Safe Patient Handling and Movement Training Curricula Suggestions

This appendix provides suggestions for SPHM curricula for staff, peer leaders, and facility coordinators.

### Staff

All staff members who move and handle patients should participate in SPHM staff awareness training. This training should include basic information about the rationale for using patient handling and movement equipment, SPHM program elements specific to the facility's program, and tools and resources for facilitating safe patient handling and movement, such as algorithms used to determine the number of staff members and type of equipment needed for safe movement of individual patients. Various types of patient handling equipment, including lifts/slings, lateral transfer devices, repositioning aids, and more, should be shown and discussed. Training should also include information on sling selection and use and bariatric patient care.

If there is time and equipment is available, demonstrate a few key pieces of equipment, knowing that further training will be provided for proficiency. Facility coordinators, peer leaders, or education staff will be responsible for conducting competency training and skills check-offs for staff members. For a sample template for tracking staff skills and competencies, go to [www.visn8.va.gov/patientsafetycenter/safePtHandling/default.asp](http://www.visn8.va.gov/patientsafetycenter/safePtHandling/default.asp).

**Staff SPHM awareness training objectives:** On completion of this training program, participants will be able to:

- Explain why patient handling and movement equipment must be used instead of manual techniques.
- Select the appropriate piece of equipment and slings for patients with a variety of medical and physical conditions.
- Relay the elements of the facility SPHM program.
- Provide safe and sensitive bariatric patient care.

### SPHM Peer Leaders

Special training that is more in-depth than staff training should be offered to peer leaders. This should provide scientific evidence for instituting SPHM programs, introduce SPHM program elements that are part of the facility program, and—to ensure success—make peer leaders aware of tools and resources that will facilitate acceptance of the program and promote safe patient handling and movement. As in the staff training, various types of patient handling equipment (e.g., lifts/slings, lateral transfer devices, repositioning aids, and more) should be shown and discussed, and sling selection and use and bariatric patient care should be covered. If time and equipment is available, demonstrate a few key pieces of equipment.

In addition to the SPHM information provided, peer leader training programs should address these subjects: adult education, change management strategies, and coaching techniques.

**Peer leader SPHM training objectives:** On completion of this training program, participants will be able to:

- Relay the rationale for implementing a safe patient handling and movement program.
- Relay the elements of the facility's SPHM program.
- Identify ergonomic and other hazards in health care environments.
- Explain the relationship between ergonomics and risk from patient handling activities.
- Understand and facilitate the support processes needed for an effective program.
- Select and safely use the appropriate piece of equipment and slings for patients with a variety of medical and physical conditions.
- Institute strategies for safe and sensitive bariatric patient care.
- Utilize change strategies to facilitate co-worker adoption of safe patient handling behaviors.
- Effectively coach and train co-workers.

Peer leaders will become the patient handling equipment “super users” on their units or in their clinical areas. To attain this designation, peer leaders need extra training on the use of equipment. The best resources for this training are the equipment manufacturers, but such involvement is not always possible. Facility champions or unit peer leaders with advanced expertise may need to take on the training role.

Another important consideration is the need for equipment users to understand the importance of thinking through the best and most sensitive approaches when using the equipment with patients.

Facility coordinators or education staff will be responsible for conducting competency training and skills check-offs for peer leaders. For a sample template to track peer leader skills and competencies, go to [www.visn8.va.gov/patientsafetycenter/safePtHandling/default.asp](http://www.visn8.va.gov/patientsafetycenter/safePtHandling/default.asp).

### **SPHM Facility Coordinators**

Facility SPHM coordinators must be able to relay information required to train staff and peer leaders, and thus must have a higher level of knowledge than either. Such information can be obtained from this white paper and from journal articles, books, Web sites, and conferences. See Chapter 6 for lists of SPHM resources, including these:

Fell-Carlson, D., ed. *Working Safely in Health Care: A Practical Guide*. New York: Delmar Thomson Learning Publishing Company, 2007.

Hudson, A. “Back injury prevention in health care” in *Handbook of Modern Hospital Safety*, 2nd ed., edited by W. Charney. New York: CRC Press, Taylor & Francis Group, 2010.

Nelson, A. L., ed. *Safe Patient Handling and Movement: A Guide for Nurses and Other Health Care Providers*. New York: Springer Publishing Company, 2006.

Nelson, A. L., K. Motacki, & N. Menzel, eds. *The Illustrated Guide to Safe Patient Handling and Movement*. New York: Springer Publishing Company, 2009.

U.S. Department of Veterans Affairs. *Safe Patient Handling Guidebook for Facility Champions/Coordinators*. [www.visn8.med.va.gov/PatientSafetyCenter/safePtHandling](http://www.visn8.med.va.gov/PatientSafetyCenter/safePtHandling).



# APPENDIX R

## PHAMP Marketing Activities/Strategies Aimed at Staff

The importance of marketing in support of a patient handling and movement program (PHAMP) or safe patient handling and movement (SPHM) program is discussed in Chapter 4: Facilitating a Patient Handling and Movement Program and Technology Acceptance. This appendix suggests marketing activities suitable for such an effort.

### Peer leader unit walk-through

- Activities:
  - Walk through units.
  - Ask staff questions on equipment use and usability.
  - Ask staff if they have any questions about equipment or related issues.
  - Give awards for answering questions correctly, etc.
  - After the walk-through, discuss the findings.
- Coordination of activities:
  - Determine activities to include.
  - Determine date/time/length of activity.
  - Ask supervisors to permit peer leaders to participate.
  - Advise unit supervisors of date and time.
  - Write down questions for peer leaders to ask staff.
  - Order T-shirts or pins for peer leaders to wear.
  - Order awards.
  - Other

### Vendor equipment fairs

### Skills/equipment fair

### Bulletin boards

Post information such as the following on bulletin boards throughout hospital; note peer leader involvement.

- Facility/unit patient handling injury data/goal to reduce number of injuries

- Other facility/unit information
- Results of unit staff completing the Perception of High-Risk Task Survey Tool (Appendix H)
- Algorithms for determining the need for PHAM equipment
- Photos of peer leaders
- Research data
- Photo of nurse executive/administrator/staff in a ceiling lift
- SPHM articles
- Quality data related to SPHM
- Information on conferences/meetings related to SPHM
- Safety huddle recommendations
- Best practices from peer leader conference calls

### Facility newsletter/e-mails

Publish or send out articles on a regular basis that promote peer leaders, the SPHM program, positive results from engaging in safe patient handling and movement, etc.

### Screensaver with SPHM or peer leader logo

### Nurse's Week

Showcase peer leaders as part of plans for this week.

### Letter/e-mail to employees launching program

### Open house after installation

Have the facility director be the first person lifted in a demonstration.

### Competitive games

- Have peer leaders lead their unit/area team
- Competition between units
- Game show, relay race, Safe Patient Handling Jeopardy, etc.
- Have peer leaders and staff write questions

**SPHM Walk** (Organize hospital-wide “walk” for SPHM.)

**Brochures/fliers/posters that promote peer leader Web site training**

- Include rationale for safe patient handling and the peer leader program.
- Include content outline, etc.
- Note that CEUs are offered.

**Develop/produce facility peer leader video**

- Light-hearted/fun video – show use of algorithms and equipment (right way/wrong way)
- Medical media

**Promotional items**

- Create SPHM program logo/title.
- Create peer leader logo/title.
- Labels: “I got caught lifting safely,” “Lifting patients safely keeps staff healthy,” “No Lifting” sign on pin or sticker, etc.
- Pens, pins, mugs, T-shirts, caps, buttons, banners, etc.
- Awards
- Other

**New employee orientation**

- Include peer leaders in the development of SPHM information.
- Include information on the peer leader program.
- Have peer leaders conduct the SPHM training piece of new employee orientation.

**SPHM poster to promote whole program**

# APPENDIX S

## SAFE PATIENT HANDLING PEER LEADER Unit Activity and Program Status Log

Type of unit: \_\_\_\_\_ Peer leader: \_\_\_\_\_

Dates included in this report: Sunday \_\_\_\_\_ through Saturday \_\_\_\_\_

### Part 1: Being a peer leader for your clinical unit

Indicate the number of times during the past week...	NUMBER
a. One of your co-workers asked for your advice about patient handling and movement.	_____
b. You met in person with a nurse <i>one-to-one</i> about patient handling tasks.	_____
c. You met in person with staff in a <i>group</i> setting about patient handling tasks.	_____
d. You demonstrated the use of patient <i>lifting</i> equipment (portable or ceiling-mounted sling lifts, stand assist lifts, etc.).	_____
e. You demonstrated the use of <i>other</i> patient handling or movement equipment (lateral transfer aids, stand-assist aids, transfer/dependency chairs, transfer/gait belts, etc.).	_____
f. You were asked to deal with a problem in the operation of a lifting device.	_____

### Part 2: Other activities related to being a peer leader

Indicate the number of times during the past week...	NUMBER
a. You demonstrated the use of the algorithms for safe patient handling and movement or one of your co-workers asked for your advice about their use.	_____
b. You were asked to evaluate a potential ergonomic/safety hazard on your unit.	_____
c. You performed an ergonomic hazard evaluation on your unit.	_____
d. You led an AAR.	_____
e. You participated in an AAR led by another.	_____
f. You attended activities related to being a peer leader other than those above (meetings w/nurse manager, other peer leaders, site coordinator, or training, etc.).	_____
g. You completed paperwork related to being a peer leader.	_____
h. You asked your nurse manager for support/info/help related to being a peer leader.	_____



# APPENDIX T

## Patient Care Equipment Use Survey

--	--	--	--	--

**How many times in a typical day would you say you use the following patient care aids?**

1. Powered full-body sling lifts (ceiling-mounted)  
 0-None    1    2    3-4    5-6    7-8    9-10    Greater than 10    N/A
2. Powered full-body sling lifts (portable base)  
 0-None    1    2    3-4    5-6    7-8    9-10    Greater than 10    N/A
3. Mechanical lateral transfer aids  
 0-None    1    2    3-4    5-6    7-8    9-10    Greater than 10    N/A
4. Friction reducing lateral aids  
 0-None    1    2    3-4    5-6    7-8    9-10    Greater than 10    N/A
5. Air-assisted lateral aids  
 0-None    1    2    3-4    5-6    7-8    9-10    Greater than 10    N/A
6. Transfer chairs  
 0-None    1    2    3-4    5-6    7-8    9-10    Greater than 10    N/A
7. Dependency/geri-chairs  
 0-None    1    2    3-4    5-6    7-8    9-10    Greater than 10    N/A
8. Powered standing assist and repositioning lifts  
 0-None    1    2    3-4    5-6    7-8    9-10    Greater than 10    N/A
9. Standing assist and repositioning aids  
 0-None    1    2    3-4    5-6    7-8    9-10    Greater than 10    N/A
10. Gait belts  
 0-None    1    2    3-4    5-6    7-8    9-10    Greater than 10    N/A